

Westwood

HEATING PRODUCTS CATALOG

New for 2005!

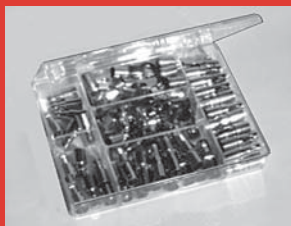
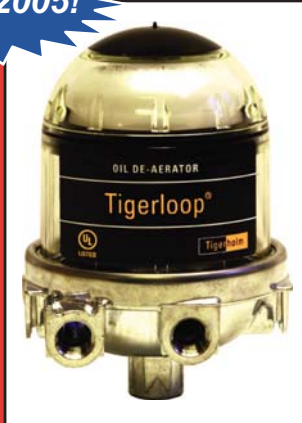

Westwood Products Inc.
South River, NJ 08882

Ph: 1-800-442-1630 Fax: 1-888-651-7798

Dear Westwood Customer,

We here at Westwood are very excited about our latest Heating Products Catalog. We have taken the items in our previous catalog and combined them with the items in our catalog supplements. The result is a new, expanded catalog with a new format. All items are now categorized by type and have been placed in different sections. This makes the items easy to find and puts related items in the same area of the catalog. For instance, all items related to electricity are in the "E" Section; filters and related items are in the "F" Section; hydronic items are in the "H" Section, and so forth.



In addition, all items have been assigned new part numbers that identify them by section. For example, electrical items start with "E"; filters start with "F"; and hydronic items start with "H", and so forth. These new numbers will make items easier to find in the catalog, and also in the price sheet. And, as our product line continues to grow, it will make adding new products more organized and orderly.

Look for this little symbol:  No. . . . it identifies the new Westwood part numbers.

To help with the transition to the new part numbers, we have included the following in the new catalog:

1. A complete cross reference in the front of the catalog by former Westwood number showing the new part number and the page on which it is found.
2. The former part number is shown next to the new part number. The former number is referred to as the "Reference No." and is generally located in the column next to the new part number.
3. A complete alphabetical index on the last two pages for easy reference.

We hope you will find this new expanded catalog, with its new format, a useful tool in quickly and accurately identifying those items you need. We stand ready to supply those needs, and look forward to being your ready source for quality heating products.

Sincerely,

A handwritten signature in black ink that reads "Pat".

Pat DiNicola
President

Terms

Invoice Terms: 2% 10 days, Net 30 days upon credit approval. No discount allowed on freight charges.

Freight: All shipments FOB our plant, South River, New Jersey.

Prices: Price lists are available only to authorized distributors. Possession of a confidential price list by anyone else does not constitute an offer to sell. All prices subject to change without notice.

Sales Policy: Westwood Products Inc. sells only to wholesale supply houses or original equipment manufacturers. All orders are subject to home office approval. Minimum order charge is \$25.00.

Late Charges: There will be a 1-1/2% per month late charge on accounts over 30 days old.

Returns: Returned goods will not be accepted without authorization and may be subject to a restocking charge.

Warranty: Westwood Products Inc. guarantees that any product of its manufacture which is found to be defective in material or workmanship and is not suitable for use or service for the purpose for which it is designed will be replaced free of charge within one year of purchase. This includes transportation costs (US only) but no costs of installation. Inspection must be performed by a Westwood representative. This shall be Westwood's maximum liability. The sale of these products under any other warranty, expressed or implied, is not authorized by Westwood.

QUICK INDEX TO SECTIONS

CONTAINS

SECTION

CROSS FORMER PART NUMBERS TO NEW  No.	CROSS REFERENCE
CHEMICALS ODOR NEUTRALIZER, FUEL TREATMENTS	C
ELECTRICAL ELECTRODES, TERMINALS, SOLID STATE IGNITERS	E
FILTERS & FILTER ELEMENTS HEATING OIL FILTERS AND RELATED ITEMS	F
HYDRONIC PRODUCTS FOR STEAM & HOT WATER HEAT	H
SERVICE PARTS & SUPPLIES PRODUCTS USED TO SERVICE & MAINTAIN BURNERS	S
TOOLS & TESTERS SPECIALIZED TOOLS & TESTERS FOR THE SERVICE TECH	T
COMPLETE ALPHABETICAL INDEX OF PRODUCTS	INDEX

CROSS REFERENCE

CROSS REFERENCE

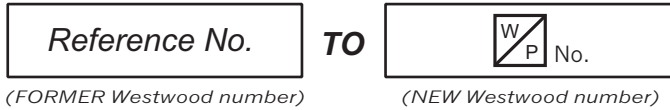

All of the items in this catalog have new part numbers, as indicated by the No. symbol. This cross reference contains a listing by former part number ("Reference No.") of those items sold by Westwood previously, and shows the corresponding new part number for them and the page number on which they may be found.

SPECIAL NOTE: FOR ELECTRODES, PORCELAINS, & Rajah™ TERMINALS

The No. for electrodes and related items is "E5- " followed by the former number.
 Example: former electrode number "1510" is now "E5-1510"

The No. for Rajah™ terminals and related items is "E9- " followed by the former number.
 Example: former Rajah™ terminal number "CT" is now "E9-CT"

Reference No.	No.	Page	Reference No.	No.	Page	Reference No.	No.	Page
Electrodes	E5 Series	E1	#15	S70-15	S2	#1251	S85-570	S6
Rajah™ Terminals	E9 Series	E30	#33 Gasket	H6-55	H1	1412	S214-12	S13
#1	S70-30	S2	34	E9-34	E33	1416	S214-16	S13
#2	S70-35	S2	#35	T100-310	T15	1890	S83-200	S4
2D21	E100-2	E37	#35 Blade	T100-312	T15	2033	E100-1	E37
#3	S70-40	S2	54	E9-54	E33	2097	E9-2097	E33
#3 Gasket	H6-50	H1	#88	S85-500	S6	2607	S86-100	S6
3L V-Belts	S30 Series	S1	#99A	S85-510	S6	2614	S86-102	S6
#4	S70-45	S2	#100 Kit	S86-120	S6	2621	S86-104	S6
4FO-30	F84-30	F8	#101	S85-520	S6	2622	S86-106	S6
4FO-IB	F84-36	F8	#135	S70-25	S2	2623	S86-108	S6
4FO-IBG	F84-48	F8	#200	S70-27	S2	2624	S86-110	S6
4L V-Belts	S40 Series	S1	#200 Kit	S86-130	S6	2630	S86-112	S6
5L V-Belts	S50 Series	S1	#271	T200-15	T17	3200	S280	S18
6CG7	E100-5	E37	475-243	S90-60	S9	3201	S280-1	S18
6FO-30	F85-30	F8	475-287	S90-62	S9	3202	S280-2	S18
6X4	E100-4	E37	575-287	S90-64	S9	3203	S280-3	S18
8FO-30	F86-30	F8	625-400	S90-66	S9	3204	S280-4	S18
#9	S70-9	S2	#695	T200-10	T16	3205	S280-5	S18
#10	S70-10	S2	951-57	S91-74	S9	3206	S280-6	S18
10FO-30	F87-24	F8	951-78	S90-68	S9	3207	S280-7	S18
#11	S70-11	S2	951-81	S90-70	S9	#3250	E64	E35
#12	S70-12	S2	951-170	S91-72	S9	#3253	E64-20	E35
12AU7	E100-6	E37	#996	T100-340	T15	3500	E9-3500	E33
12AV7	E100-7	E37	#996-W	T100-342	T15	3605	S213-5	S13
12AX7	E100-8	E37	#997	T100-370	T16	3607	S213-7	S13
12BH7	E100-9	E37	1194	S200	S13	3608	S213-8	S13
12H6	E100-10	E37	#1240	S85-530	S6	3611	S213-11	S13
12SL7	E100-11	E37	#1240C	S85-540	S6	3612	S213-12	S13
12SN7	E100-12	E37	#1242	S85-550	S6	3616	S213-16	S13
#13	S70-13	S2	#1250	S85-560	S6	4030	S90-10	S9

• REFERENCE No. IS THE FORMER WESTWOOD NUMBER •

CROSS REFERENCE

Reference No. **TO** No.

Reference No.	No.	Page	Reference No.	No.	Page	Reference No.	No.	Page
4230	S90-12	S9	46645	S100-136	S10	165284	S100-216	S10
4235	S90-14	S9	46646	S100-408	S11	165285	S100-218	S10
4725	S90-16	S9	46648	S100-156	S10	165286	S100-220	S10
4729	S90-18	S9	46775	H25-30	H5	165287	S100-222	S10
4729-1	S91-18	S9	46778	S100-120	S10	165288	S100-224	S10
4734	S90-20	S9	46912	S100-116	S10	165289	S100-226	S10
4734-1	S91-20	S9	46913	S100-150	S10	165290	S100-228	S10
5220	S90-22	S9	47101	S100-118	S10	165291	S100-230	S10
5220-1	S91-22	S9	47102	S100-140	S10	165292	S100-232	S10
5225	S90-24	S9	47103	S100-502	S11	165293	S100-234	S10
5225-1	S91-24	S9	47104	S100-504	S11	165294	S100-236	S10
5229	S90-26	S9	47105	S100-406	S11	165295	S100-238	S10
5229-1	S91-26	S9	47225	S100-500	S11	165296	S100-240	S10
5234	S90-28	S9	47411	S100-410	S11	165297	S100-242	S10
5234-1	S91-28	S9	47490	S100-128	S10	165298	S100-244	S10
5495	H25-10	H5	47491	S100-132	S10	165299	S100-246	S10
5504	S100-158	S10	47492	S100-122	S10	165300	S100-248	S10
5506	S100-160	S10	47493	S100-124	S10	165301	S100-250	S10
5508	S100-162	S10	47495	S100-144	S10	165302	S100-252	S10
5510	S100-164	S10	47615	S100-108	S10	165303	S100-258	S10
5512	S100-166	S10	47738	S100-142	S10	165304	S100-260	S10
5514	S100-168	S10	47925	S100-400	S11	165305	S100-262	S10
5515	S100-170	S10	48302	S100-134	S10	165306	S100-264	S10
5516	S100-172	S10	48363	S100-138	S10	165307	S100-266	S10
5549	H25-12	H5	48365	S100-148	S10	165308	S100-268	S10
5551	S100-174	S10	49488	S100-106	S10	165309	S100-270	S10
5554	S100-176	S10	49609	S100-402	S11	165377	S100-254	S10
5561	S100-178	S10	49611	S100-154	S10	165378	S100-256	S10
5563	S100-180	S10	52420	S100-126	S10	165380	S100-272	S10
5727	E100-3	E37	52576	S100-130	S10	165381	S100-274	S10
5729	S90-30	S9	58156	S100-412	S11	166664	S100-200	S10
5729-1	S91-30	S9	75260	S100-404	S11	166665	S100-202	S10
5734	S90-32	S9	75991	S100-328	S11	166666	S100-204	S10
5734-1	S91-32	S9	75995	S100-326	S11	166667	S100-206	S10
5738	S90-34	S9	75996	S100-334	S11	166668	S100-208	S10
5738-1	S91-34	S9	135392	H25-16	H5	166669	S100-210	S10
6325	S90-36	S9	135393	H25-15	H5	169128	S100-600	S11
6329	S90-38	S9	141608	S70-50	S2	169129	S100-610	S11
6329-1	S91-38	S9	141612	S70-51	S2	169130	S100-620	S11
6334	S90-40	S9	144824	S70-52	S2	169131	S100-630	S11
6334-1	S91-40	S9	144434	H25-18	H5	169132	S100-640	S11
6338	S90-42	S9	144435	H25-17	H5	169133	S100-650	S11
6338-1	S91-42	S9	144826	H25-19	H5	AECF	E9-AECF	E34
6342	S90-44	S9	144827	H25-20	H5	AO25	F15-36	F7
6342-1	S91-44	S9	146010	S100-100	S10	AO25B	F15-48	F7
6346	S90-46	S9	146011	S100-102	S10	AO30	F75-12	F7
7243-1	S91-48	S9	146013	S100-104	S10	AO70	F35-24	F7
7328	T100-50	T12	161963	S100-300	S11	ARM-3L	S300-404	S19
7846-1	S91-50	S9	161964	S100-302	S11	ARM-3S	S300-400	S19
11498	H25-31	H5	161965	S100-306	S11	ARM-5C	S300-412	S19
11937	H25-35	H5	161966	S100-308	S11	ARM-5L	S300-406	S19
21551	S100-322	S11	161967	S100-310	S11	ARM-5S	S300-402	S19
21552	S100-324	S11	161968	S100-312	S11	ARM-14	S300-408	S19
21553	S100-330	S11	161969	S100-314	S11	ARM-15	S300-410	S19
21554	S100-332	S11	161970	S100-316	S11	B-1	E115-2	E37
45330	S100-114	S10	161971	S100-318	S11	B-2	E115-3	E37
45331	S100-146	S10	161972	S100-320	S11	BA-1	E115-6	E37
45764	S100-112	S10	162787	S100-304	S11	BG-4	F80-52	F8
45765	S100-152	S10	165282	S100-212	S10	BG-20	F90-52	F8
46644	S100-110	S10	165283	S100-214	S10	BG-25	F10-52	F8

• REFERENCE No. IS THE FORMER WESTWOOD NUMBER •

Please order by No.

CROSS REFERENCE

Reference No.	TO	<div style="border: 1px solid black; display: inline-block; padding: 2px;"> No. </div>
---------------	-----------	---

Reference No.	WP No.	Page	Reference No.	WP No.	Page	Reference No.	WP No.	Page
BG-33	H24-40	H4	NAS-W1	T100-206	T13	TM-30L	E80	E36
BG-2002	F92-52	F8	Nyloshaft 6"	S85-6	S5	TM-30S	E80-1	E36
BH-1	E115-1	E37	Nyloshaft 10"	S85-10	S5	TMK-60	E80-2	E36
BW-1	E115-4	E37	Nyloshaft 12"	S85-12	S5	Type ET	E9-TYPE ET	E32
BW-2	E115-5	E37	Nyloshaft 15"	S85-15	S5	Type F	E9-TYPE F	E32
CBS	E9-CBS	E32	Nyloshaft 30"	S85-30	S5	Type M	E81	E36
CG-20	F90-50	F8	O Rings	T32-25	T5	Type ST	E9-TYPE ST	E32
CG-25	F10-50	F8	OBS-38	S305-37	S20	Type W	E81-10	E36
CG-70	F30-50	F8	OBS-50	S305-50	S20	ULTRAGLO	E160	E41
CG-300	F75-50	F8	OBS-75	S305-75	S20	VB-1049	S20-16	S1
CG-1210	F93-50	F8	OBS-100	S305-100	S20	VG-4	F80-54	F8
CG-2002	F92-50	F8	OBS-125	S305-125	S20	VG-25	F10-55	F8
CG-B4	F80-50	F8	OBS-153	S305-150	S20	VG-2002	F92-54	F8
CK-1	E9-CK-1	E33	OL-711	S214-25	S13	Water Pressure	H35	H6
CO2 Cartridges	T32-30	T6	P4FO-IB	F80-36	F6	Gauge Adaptor		
CP-1	T100-300	T14	PA-25	F10-48	F6	WP-1	T100-330	T15
ECF	E9-ECF	E34	PD-40	H24-10	H4	WRM-798	H24-62	H4
FP2-E1	H76-2	H7	PF-20	F90-36	F6	WRM-858	H24-60	H4
FP2-E2	H76-3	H7	PF-30	F91-36	F6	WTG-54VL	E140	E38
FP2-M2	H76	H7	PM-12	F93-36	F6	WTG-54VLW	E140-1	E38
FP2-R2	H76-1	H7	PM-12-RO	F94-36	F6	WTG-B	E141	E38
FP3-M1	H75	H7	PP-20	F92-36	F6	WTG-DB	E151	E40
FP3-R1	H75-1	H7	PR-12	S300-424	S19	WTG-DK	E151-1	E40
FT-1	T200-80	T17	PR-18	S300-426	S19	WTG-DK1	E151-2	E40
Gauge Adaptor	S100-10	S11	PR-24	S300-428	S19	WTG-DO	E151-3	E40
GGW-6812	H6-10	H1	PR-36	S300-430	S19	WTG-EB	E142	E38
GGW-7102	H6-15	H1	PR-48	S300-432	S19	WTG-EK	E142-1	E38
GGW-7103	H6-20	H1	PTA-224C	H25	H5	WTG-EM	E142-2	E38
GGW-7105	H6-25	H1	PTA-234C	H25-1	H5	WTG-EO	E142-3	E38
GV-22	H7	H2	PTA-322C	H25-2	H5	WTG-K	E143	E38
HDT 303K	T100-120	T12	PTA-322L	H25-3	H5	WTG-KM	E143-1	E39
HK-17	T200-58	T17	QCK-1 Kit	T32-20	T5	WTG-KWM	E143-2	E39
HWT-A	H25-52	H5	RD-95	T100-350	T15	WTG-O	E143-3	E39
HWT-D	H25-90	H5	RD-95-W	T100-352	T15	WTG-RB	E144	E39
Ignitor Gauge	T100-220	T13	Red. Bushing,	S83-10	S4	WTG-RK	E144-1	E39
IJW-12	T100-80	T12	5/16 X 7/16			WTG-RM	E144-2	E39
IJW-18	T100-82	T12	RK-97	T200-56	T17	WTG-RO	E144-3	E39
IJW-36	T100-84	T12	#RS-3350	E64-5	E35	WTG-RWM	E144-4	E39
JHS	S150	S12	SD Tester	T100-15	T12	WTG-UB2	E145	E39
JK-52	H24-15	H4	Service-Saw	S400	S21	WTG-UK2	E145-1	E39
JW-12	T100-70	T12	Sight Glass,			WTG-UM	E146	E39
JW-18	T100-72	T12	1/8" Thick	S312 Series	S20	WTG-UM1	E147	E40
JW-36	T100-74	T12	3/16" Thick	S318 Series	S20	WTG-UM1DH	E147-1	E40
LG-300	F75-56	F8	1/4" Thick	S325 Series	S20	WTG-UM1DOH	E147-2	E40
Lighter, 12"	T34-40	T6	SK-59	T200-52	T17	WTG-UM1DOWR	E147-3	E40
LK-66	T200-50	T17	SS KIT	S70-60	S2	WTG-UM1OH	E147-4	E40
LV Tester	T100-10	T12	SW-4	S300-414	S19	WTG-UM1SDH	E147-5	E40
MK-3 Kit	T34-30	T6	SW-5	S300-416	S19	WTG-UO2	E148	E40
ML-3	T32	T5	SW-6	S300-418	S19	WTG-UWM	E149	E40
ML-26	T34-35	T6	SW-8	S300-420	S19	WTG-UWM1	E150	E40
ML-3-150	T32-10	T5	SW-9	S300-422	S19	WTG-UWM1DH	E150-1	E40
ML-3-150-UPG	T32-11	T5	T-160	T100-125	T12	WTG-UWM1DOH	E150-2	E40
ML-3-P1000	T32-15	T5	T-220	T100-130	T12	WTG-UWM1DOWR	E150-3	E40
ML-3-PQ	T32-16	T5	T-571	H25-50	H5	WTG-UWM1OH	E150-4	E40
MR-1X2	T34-10	T6	T-571 Brass	H25-51	H5	WTG-UWM1SDH	E150-5	E40
MR-2X3	T34-15	T6	T-572 Brass	H25-53	H5	XK-104	T200-54	T17
MR-4	T34-25	T6	T-1050	H25-54	H5			
NAS-A1	T100-204	T13	T-1051	H25-55	H5			
NAS-ABW	T100-200	T13	TA	S85-130	S5			
NAS-B1	T100-202	T13	TB-60	T100-230	T13			

• REFERENCE No. IS THE FORMER WESTWOOD NUMBER •

CHERRY BLAST  **ODOR NEUTRALIZER**

General purpose industrial strength odor neutralizer. Especially effective on fuel oil and other basement odors, it leaves a clean, fresh scent that customers will like.

- ▶ Neutralizes fuel oil odors with a pleasant cherry scent
- ▶ Easy to spread granules clean up easily

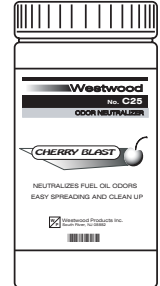

 No. **C25**

 No.	Description
C25	CHERRY BLAST fuel oil odor neutralizer, 1 quart container

WP-3

HEATING OIL ADDITIVE

Next generation fuel oil additive that stabilizes fuel, dissolves sludge, lowers pour point and disperses water. Helps prevent fuel line and oil filter freeze-ups.

- ▶ Stabilizes fuel and dissolves sludge
- ▶ Inhibits rust and tank corrosion
- ▶ Lowers pour point for better cold weather combustion
- ▶ Disperses water and prevents waxing
- ▶ Melts ice and helps prevent fuel line freeze-ups



 No. **C50**

 No.	Description
C50	WP-3 premium fuel oil additive, 8 oz. bottle (treats 275 gal. tank)
C50-1	WP-3 premium fuel oil additive, 1 gallon "Tip-N-Pour" bottle
C50-55	WP-3 premium fuel oil additive, 55 gallon drum

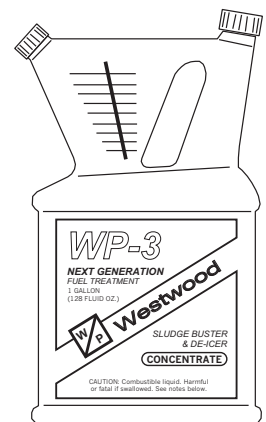

 No. **C50-1**

Please order by  No.

A test you can do yourself!

EVALUATING FUEL OIL ADDITIVES

(presented at the 1996 US Department of Energy Oil Heat Technology Conference, Brookhaven National Laboratory, Upton, NY)

Jar Test *(Simulates "Life in a tank")*

This test is intended to show an additive's relative ability to control sludge, keep metal surfaces clean, and protect tanks against corrosion. For each additive, place: 1" of water, a metal "coupon", a little sludge, fuel oil, and the additive to be tested (at recommended rate) in a 1 quart jar. Make sure to prepare one jar with no additive for comparison later on. Cover loosely and simulate "Life in a tank" by changing the oil every month. Stop the test when the untreated jar shows deterioration of the "coupon" and sludge formation. Inspect the "coupon" and pour the contents through a strainer.

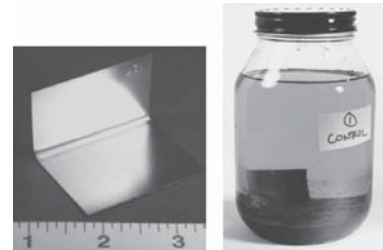

Metal "coupon" 1 quart jar

SAMPLE TEST RESULTS

Additive name (manufacturer)	Metal "coupon"	Residue in strainer
No additive		
<div style="border: 1px solid black; padding: 2px; display: inline-block; margin-bottom: 5px;">The ONLY one that works! (see page C3)</div> Fuel Right EP (Fairville Products)		
STR-2⁺ (Technol)		
HOT (FPPF)		
Sludge Solve (Comstar)		

Curious about your additive? Westwood has test results for most popular fuel additives.

Call 1-800-442-1630 for full color pictures.



Premium
**FUEL TREATMENT
 AND ADDITIVE PRODUCTS**



AVAILABLE IN CONVENIENT BOTTLE SIZES FOR
 SPOT TREATMENT OF INDIVIDUAL TANKS OR IN
 DRUMS FOR BULK TREATMENT AT THE RACK

 No.	Fuel Right®	Description	Size (Treats)
C70-8 C70-32 C70-55	EP	The "Flagship" of the line, EP prevents sludge buildup, breaks down old sludge, prevents corrosion of tanks and filter housings, and protects against winter freeze-ups.	8 oz. (275 gal.) 1 qt.*(1,000 gal.) 55 gallon drum
C72-16	COLD FLOW	Protects outdoor tanks during winter months. Lowers pour point to below -25°F and reduces CFPP by 10° to 25°F, depending on fuel. Also contains GLYCOL ETHER to provide anti-freeze protection for fuel systems with water.	16 oz. (250 gal.)
C72-55	BULK COLD FLOW	Identical to bottled COLD FLOW but bulk packaged for greater economy.	55 gallon drum
C74-8	SUMMER DIESEL	Provides protection against fuel system and injector fouling, reduces smoking, lubricates the injection pump for less wear and longer life. Used during the non-freezing months.	8 oz. (100 gal.)
C76-8	WINTER DIESEL	Combines the ingredients in SUMMER DIESEL and COLD FLOW for total diesel engine and fuel system protection in cold winter months.	8 oz. (100 gal.)
C77-90	BULK WINTER DIESEL	Identical to bottled WINTER DIESEL but more concentrated for convenience and economy. The ultimate diesel fuel or heating oil additive for the winter months.	55 gallon drum (Dose Ratio: 1 to 2000)
C77-60	BULK 6000	For injection at the rack or injection of incoming fuel while unloading. Has active ingredients of FUEL RIGHT EP adjusted for bulk treatment.	55 gallon drum (Dose Ratio: 1 to 6000)
C77-75	BULK 7500	For splash treatment of incoming fuel in the transport, the offloading line, or by pouring directly into the bulk tank. It is FUEL RIGHT BULK 6000 adjusted for splash treating.	55 gallon drum (Dose Ratio: 1 to 7500)

* May be used to splash treat delivery trucks at a rate of 1 qt. per 2,800 gal.

Fuel Right® Technical Support

Users have access to testing of fuels for quality and stability, and help in identifying fuel-side problems.

Please order by  No.

STANDARD ELECTRODES



NOTE: Electrode and related items part numbers are now "E5-" followed by the former number.

Example:

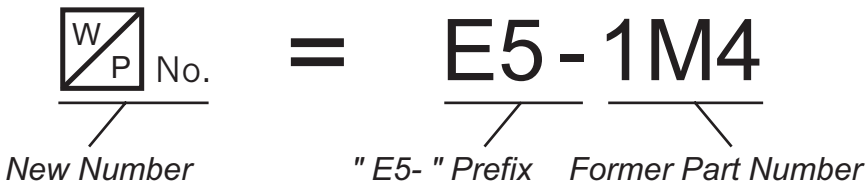

Type 1M

Insulator length	WP No.
4"	E5-1M4
4-1/4"	E5-1M4-1/4
4-1/2"	E5-1M4-1/2
5"	E5-1M5
6"	E5-1M6
7"	E5-1M7
8"	E5-1M8

Type 2M

Insulator length	WP No.
4"	E5-2M4
4-1/2"	E5-2M4-1/2
5"	E5-2M5
5-1/2"	E5-2M5-1/2
6"	E5-2M6
7"	E5-2M7
8"	E5-2M8

Type 3M

Insulator length	WP No.
4"	E5-3M4
4-1/2"	E5-3M4-1/2
5"	E5-3M5
5-1/2"	E5-3M5-1/2
6"	E5-3M6
7"	E5-3M7
8"	E5-3M8

Type 4M

Insulator length	WP No.
4"	E5-4M4
4-1/4"	E5-4M4-1/4
4-1/2"	E5-4M4-1/2
5"	E5-4M5
6"	E5-4M6
7"	E5-4M7
8"	E5-4M8

Type 5M

Insulator length	WP No.
4"	E5-5M4
5"	E5-5M5
6"	E5-5M6

Type 2F

Insulator length	WP No.
4"	E5-2F4
4-1/2"	E5-2F4-1/2
5"	E5-2F5
5-1/2"	E5-2F5-1/2
6"	E5-2F6
7"	E5-2F7
8"	E5-2F8

Type 3F

Insulator length	WP No.
4"	E5-3F4
4-1/2"	E5-3F4-1/2
5"	E5-3F5
5-1/2"	E5-3F5-1/2
6"	E5-3F6
7"	E5-3F7
8"	E5-3F8

Westwood electrodes & insulators

HIGH DIELECTRIC STRENGTH • PRECISION DIMENSIONS

<p>"A" 2-9/16" 9/16"</p> <p>Ace "A" E5-100 Ace 5" E5-100B Ace 6" E5-100C Ace 7"</p>	<p>7" 1-3/4" 9/16"</p> <p>Arco E5-124</p>	<p>"A" 3-9/16" 1-1/8" 7/16"</p> <p>ABC 6" E5-144A ABC 5" E5-144B ABC 4-1/2" E5-144C ABC 4" E5-144D ABC 3" E5-144E ABC 2" E5-144F ABC 1-3/4" E5-144G ABC None E5-144H</p>
<p>5" 9/16" 9/16"</p> <p>Ace E5-100A</p>	<p>4" 2" 9/16"</p> <p>Arco E5-127</p>	<p>4-1/4" 4" 1-9/16" 9/16"</p> <p>ABC E5-146</p>
<p>4" 2-1/4" 9/16"</p> <p>Acme E5-102A</p>	<p>4" 2" 9/16"</p> <p>Arco E5-127A</p>	<p>"A" 4" 1" 9/16"</p> <p>ABC "A" E5-146A ABC 4-1/4" E5-146B ABC none E5-146C ABC 4-1/2"</p>
<p>5" 1-1/4" 9/16"</p> <p>Acme E5-102B</p>	<p>5" 1-9/16" 9/16"</p> <p>Armstrong E5-128</p>	<p>4" 1-9/16" 9/16"</p> <p>ABC E5-146A</p>
<p>5" 7/16" 9/16"</p> <p>Acme E5-107</p>	<p>8" 1-3/4" 9/16"</p> <p>ABC (with bracket) E5-130</p>	<p>4" 1-9/16" 9/16"</p> <p>ABC E5-147</p>
<p>6" 2-3/4" 9/16"</p> <p>Aeroil E5-108</p>	<p>5" 1-9/16" 9/16"</p> <p>ABC (with bracket) E5-130</p>	<p>5" 3-9/16" 9/16"</p> <p>ABC E5-148</p>
<p>4-1/4" 1-1/4" 7/16"</p> <p>Aero E5-109</p>	<p>7" 1-1/8" 7/16"</p> <p>ABC (with bracket) E5-130A</p>	<p>4" 1-5/8" 9/16"</p> <p>ABC E5-148A</p>
<p>4-1/4" 2" 7/16"</p> <p>Aero E5-110</p>	<p>7" 1-1/8" 7/16"</p> <p>ABC (with bracket) E5-130A</p>	<p>4" 1-9/16" 9/16"</p> <p>ABC E5-148B</p>
<p>4" 7/16" 9/16"</p> <p>Aero E5-110B</p>	<p>"A" 1-9/16" 9/16"</p> <p>ABC "A" E5-131A ABC 4" E5-132A ABC 5"</p>	<p>3" 5" 3-9/16" 9/16"</p> <p>ABC E5-148C</p>
<p>4" 1" 1/2"</p> <p>Alcoa E5-111</p>	<p>"A" 1-9/16" 9/16"</p> <p>ABC "A" E5-131A ABC 4" E5-132A ABC 5"</p>	<p>5" 3-9/16" 9/16"</p> <p>spring ABC E5-148D</p>
<p>A 4" 13/16" 9/16"</p> <p>Aero "A" E5-111A Aero none E5-111D Aero 9-1/2" E5-111E Aero 13-1/2" E5-111F Aero 4-3/4" E5-111G Aero 7-1/2"</p>	<p>"A" 1-9/16" 9/16"</p> <p>ABC "A" E5-131 ABC 4" E5-132 ABC 5"</p>	<p>5" 3-9/16" 9/16"</p> <p>spring ABC E5-148E</p>
<p>7" 1-3/4" 9/16"</p> <p>Arco E5-121</p>	<p>5" 3-9/16" 9/16"</p> <p>ABC L R E5-133</p>	<p>2-3/4" 5" 3-9/16" 9/16"</p> <p>ABC E5-148F</p>
<p>5" 1-1/2" 9/16"</p> <p>Arco E5-122</p>	<p>A 4" 1-5/8" 9/16"</p> <p>ABC "A" E5-137B ABC 1-1/2" E5-137C ABC 4-1/4" E5-137E ABC 7-1/2"</p>	<p>5" 3-3/4" 9/16"</p> <p>spring ABC E5-148H</p>
<p>5" 1-3/4" 9/16"</p> <p>Arco E5-123</p>	<p>A 4" 1-5/8" 9/16"</p> <p>ABC "A" E5-137B ABC 1-1/2" E5-137C ABC 4-1/4" E5-137E ABC 7-1/2"</p>	<p>3" 5" 2-3/4" 9/16"</p> <p>ABC ← with 6" spring E5-148J</p>

ELECTRODES







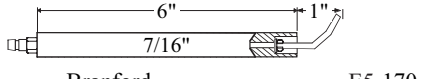
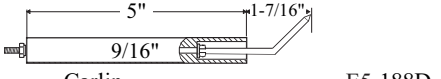
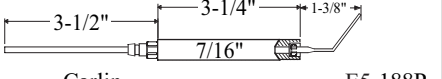
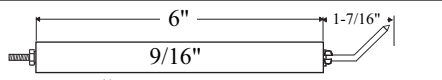
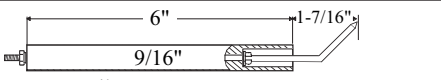
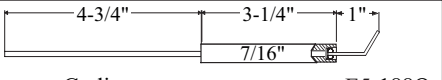
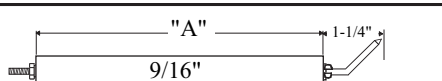
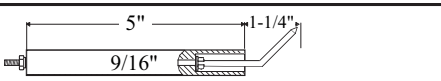
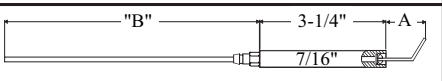
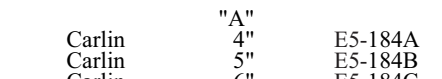
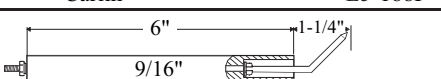
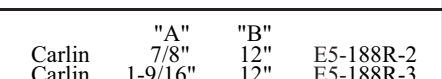
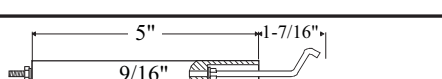
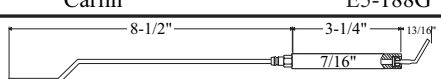
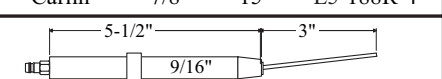
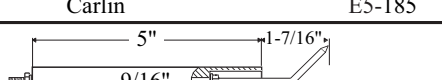
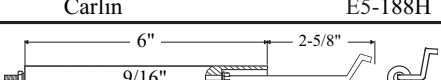
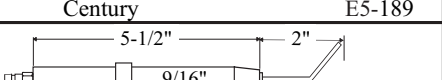

Westwood electrodes & insulators

HIGH DIELECTRIC STRENGTH • PRECISION DIMENSIONS

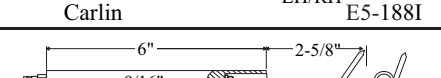
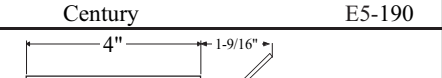
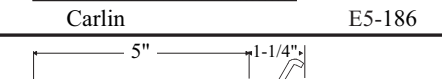
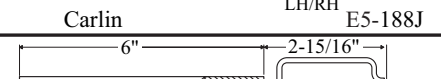
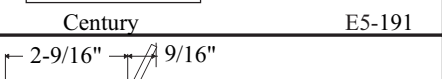
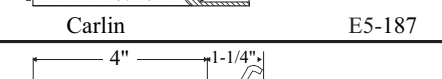
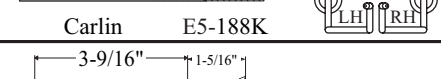
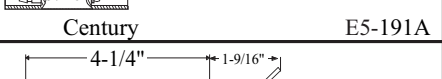
<p>ABC E5-148M</p>	<p>Beckett E5-151L</p>	<p>Beckett AF II HLX E5-151Z</p>
<p>ABC Sunray OE-1 E5-148Q</p>	<p>Beckett E5-151M</p>	<p>Beckett AF 15 E5-152B</p>
<p>ABC Sunray E5-148R ABC Sunray E5-148R1 ABC Sunray E5-148S</p>	<p>Beckett E5-151N</p>	<p>Beckett AF II FBX E5-152C</p>
<p>Beckett E5-151A</p>	<p>Beckett E5-151O</p>	<p>Bethlehem E5-156</p>
<p>Beckett E5-151B</p>	<p>Beckett E5-151P Beckett E5-151P-1 Beckett E5-151P-2</p>	<p>Bettendorf E5-157</p>
<p>Beckett E5-151C</p>	<p>Beckett E5-151Q Beckett (without spring) E5-151Q1</p>	<p>Bettendorf E5-159</p>
<p>Beckett E5-151D</p>	<p>Beckett E5-151R Beckett E5-151R-1 Beckett E5-151R-2 Beckett E5-151R-3 Beckett E5-151R-4</p>	<p>Bettendorf E5-160</p>
<p>Beckett E5-151E</p>	<p>Beckett E5-151S Beckett E5-151T</p>	<p>Bettendorf E5-160A</p>
<p>Beckett E5-151E1</p>	<p>Beckett E5-151R Beckett E5-151R-1 Beckett E5-151R-2 Beckett E5-151R-3 Beckett E5-151R-4</p>	<p>Bettendorf E5-160B</p>
<p>Beckett E5-151F</p>	<p>Beckett E5-151S Beckett E5-151T</p>	<p>Bettendorf E5-160C</p>
<p>Beckett E5-151G</p>	<p>Beckett E5-151S Beckett E5-151T</p>	<p>Bettendorf E5-160D</p>
<p>Beckett E5-151H</p>	<p>Beckett E5-151U</p>	<p>Bettendorf E5-160E</p>
<p>Beckett E5-151I</p>	<p>Beckett E5-151V</p>	<p>Bettendorf E5-160G</p>
<p>Beckett E5-151J</p>	<p>Beckett E5-151</p>	<p>Blueray E5-1880</p>
<p>Beckett E5-151K</p>	<p>Beckett E5-152 Beckett E5-152A Beckett E5-153 Beckett E5-153A</p>	<p>Bock E5-161B</p>
<p>Beckett E5-151X</p>	<p>Bock E5-161C</p>	

Westwood electrodes & insulators

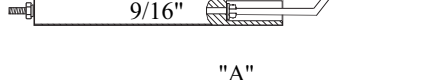
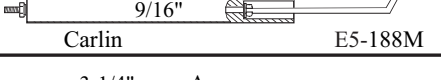
HIGH DIELECTRIC STRENGTH • PRECISION DIMENSIONS

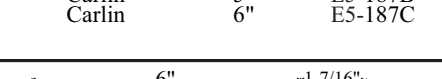
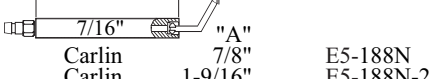
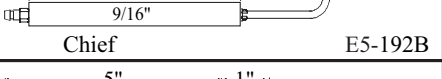
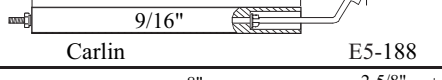
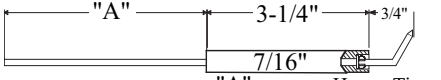
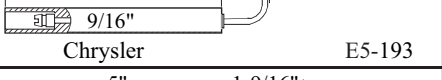
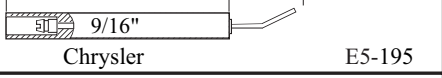
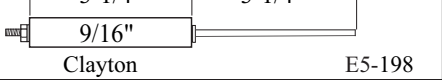
 Branford E5-170	 Carlin E5-188D	 Carlin E5-188P
 Carlin E5-184	 Carlin E5-188E	 Carlin E5-188Q
 Carlin "A" Carlin 4" E5-184A Carlin 5" E5-184B Carlin 6" E5-184C	 Carlin E5-188F	 Carlin "A" "B" Carlin 7/8" 12" E5-188R-2 Carlin 1-9/16" 12" E5-188R-3 Carlin 7/8" 15" E5-188R-4
 Carlin E5-185	 Carlin E5-188H	 Century E5-189
 Carlin E5-185A	 Carlin LH/RH E5-188I	 Century E5-190
 Carlin E5-186	 Carlin LH/RH E5-188J	 Century E5-191
 Carlin E5-187	 Carlin LH/RH E5-188K	 Century E5-191A
 Carlin E5-187A	 Carlin E5-188L	 Century E5-191B
 Carlin "A" Carlin 5" E5-187B Carlin 6" E5-187C	 Carlin E5-188M	 Chief E5-192
 Carlin E5-188	 Carlin "A" Carlin 7/8" E5-188N Carlin 1-9/16" E5-188N-2	 Chief E5-192B
 Carlin E5-188A	 Carlin "A" Heavy Tip Carlin 2-1/2" E5-188N-1 Carlin 11" E5-188N-3 Carlin 1-1/2" E5-188N-5 Carlin 8-1/2" E5-188N-6 Carlin 4-1/2" E5-188N-8 Carlin 6-1/2" E5-188N-9	 Chrysler E5-193
 Carlin "A" Carlin 7/8" E5-188B Carlin 1-9/16" E5-188B-2	 Carlin "A" Light Tip Carlin 8-1/2" E5-188N-4 Carlin 4-1/2" E5-188N-7 Carlin 6-1/2" E5-188N-10	 Chrysler E5-195
 Carlin E5-188C	 Carlin E5-188O	 Clayton E5-198
		 Clayton E5-199
		 Clayton E5-199A

ELECTRODES

Westwood electrodes & insulators

HIGH DIELECTRIC STRENGTH • PRECISION DIMENSIONS

 Clayton E5-199C	 Cleaver Brooks	 Columbia Boiler E5-207
 Clayton E5-199D	E5-205F 21 E5-205J 24 E5-205O 12 E5-205G 18-1/4 E5-205K 27 E5-205Q 30 E5-205H 19-3/4 E5-205L 14 E5-205S 21 E5-205I 15-3/4 E5-205M 27-1/2	 Columbia Boiler E5-207A
 Cleanburn E5-199Z	 Cleaver Brooks E5-205N	 Crane Crane "A" E5-213 Crane Crane none E5-214 Crane Crane 6" E5-214
 Cleanburn E5-199Z1	 Cleaver Brooks E5-205R	 Delco E5-220
 Cleaver Brooks E5-201	 Cleaver Brooks E5-205T	 Delco E5-221
 Cleaver Brooks E5-203	 Cleaver Brooks E5-205U	 Delco E5-224
 Cleaver Brooks E5-204A	 Cleaver Brooks E5-205V	 Delco E5-225
 Cleaver Brooks E5-205	 Cleaver Brooks E5-205W	 Delco E5-226
 Cleaver Brooks E5-205A Cleaver Brooks E5-205A-5	 Cleaver Brooks E5-205X	 Delco E5-227
 Cleaver Brooks E5-205A-1	 Cleaver Brooks E5-205Y	 Delco E5-228
 Cleaver Brooks E5-205A-2	 Cleaver Brooks E5-205Z	 Delco E5-231
 Cleaver Brooks E5-205B	 Cleaver Brooks E5-205Z-1	 Delco E5-232
 Coleman E5-202A	 Cleaver Brooks E5-205Z-2	 Dravo E5-232A
 Coleman E5-202B	 Cleaver Brooks E5-205Z-3	 Dravo E5-232B
 Columbia Boiler E5-206	 Cleaver Brooks E5-205D Cleaver Brooks E5-205E Cleaver Brooks E5-205E-2	 Dravo E5-232C

Westwood electrodes & insulators

HIGH DIELECTRIC STRENGTH • PRECISION DIMENSIONS

 Dravo E5-232D	 Ducane OilMaster™ E5-234L Ducane OilMaster™ E5-234M	 Electromagic E5-249A
 Dravo E5-232E		 Enterprise E5-253
 Dravo E5-232F	 Eclipse E5-235 Eclipse E5-235A Eclipse E5-235B	 Enterprise E5-253B Enterprise E5-253C Enterprise E5-253D
 Dravo E5-232G		
 Dravo E5-232H	 Eclipse E5-236	 Eroc E5-254
 Dravo E5-232I	 Eclipse E5-238	 Eroc E5-257
 Dravo E5-232J	 Eclipse E5-238B	 Esso E5-258
 Dravo E5-232L	 Economite E5-239	 Esso E5-259
 Dravo E5-232M	 Economite E5-239A	 Esso E5-259A
 Dravo E5-232N	 Economite E5-239B	 Esso E5-261
 Dravo E5-233	 Economite E5-239C	 Flame Guard E5-267A Flame Guard E5-267B Flame Guard E5-267C Flame Guard E5-267E Flame Guard E5-267F Flame Guard E5-267G
 Dravo E5-234	 Economite E5-239D	
 Ducane E5-234A Ducane E5-234B Ducane E5-234C Ducane E5-234D	 Economite E5-239E	 Flame Guard E5-267D
	 Economite E5-239F	 Fluid Heat E5-273
 Ducane E5-234E Ducane E5-234F Ducane E5-234G Ducane E5-234H Ducane E5-234I Ducane E5-234J	 Edison E5-246	 Fluid Heat E5-274
	 Edison E5-247	 Fluid Heat E5-275

ELECTRODES

Westwood electrodes & insulators

HIGH DIELECTRIC STRENGTH • PRECISION DIMENSIONS

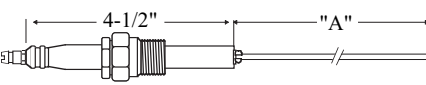
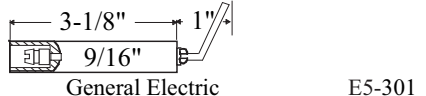
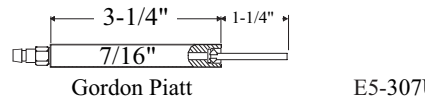
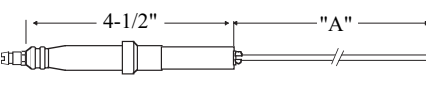
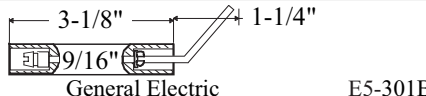
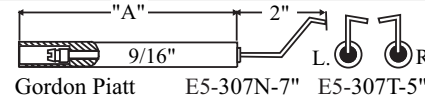
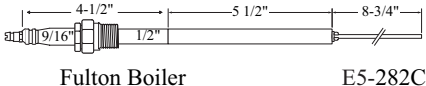
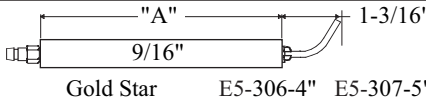
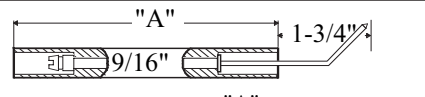
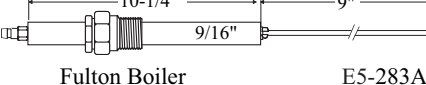
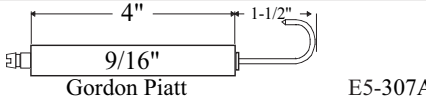
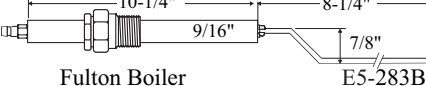
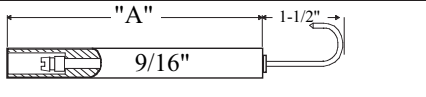
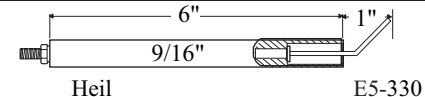
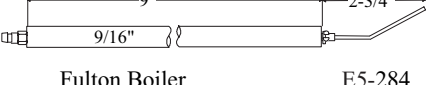
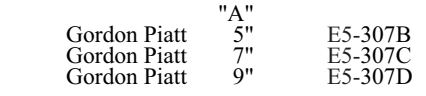
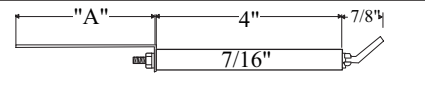
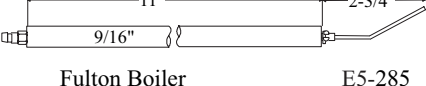
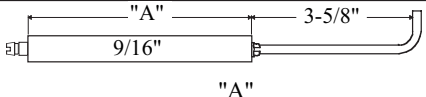
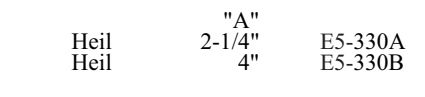
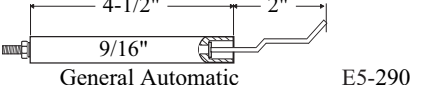
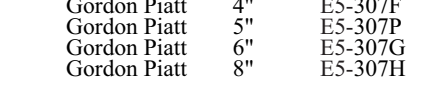
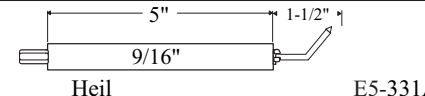
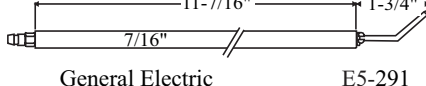
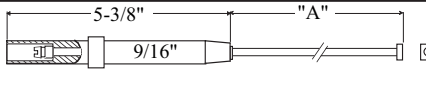
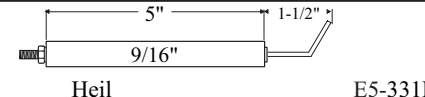
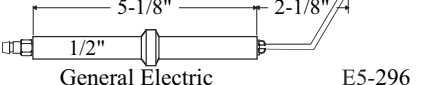
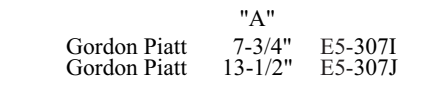
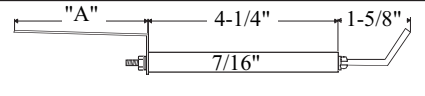
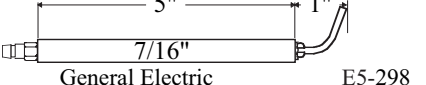
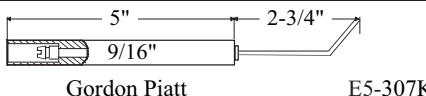
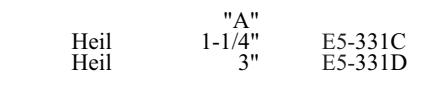
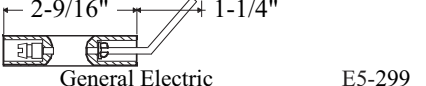
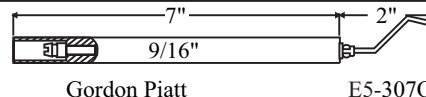
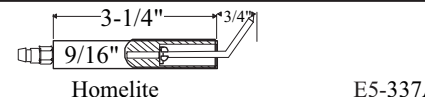
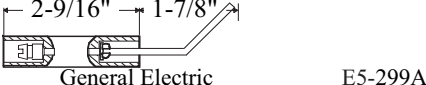
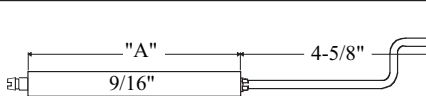
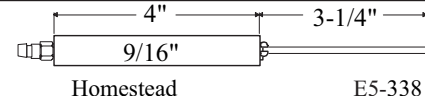
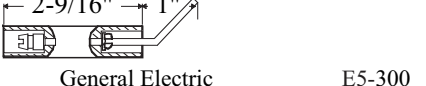
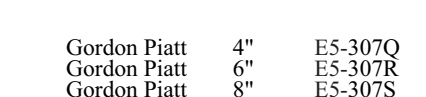
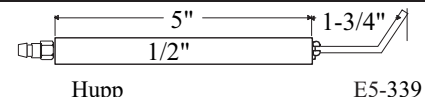
 <p>Fulton Boiler "A" E5-282 Fulton Boiler 12-1/4" E5-283 Fulton Boiler 17-1/4"</p>	 <p>General Electric E5-301 General Electric E5-301A</p>	 <p>Gordon Piatt E5-307U Gordon Piatt E5-307V</p>
 <p>Fulton Boiler "A" E5-282A Fulton Boiler 12-1/4" E5-282B Fulton Boiler 17-1/4"</p>	 <p>General Electric E5-301B General Machine E5-303</p>	 <p>Gordon Piatt E5-307N-7 Gordon Piatt E5-307T-5</p>
 <p>Fulton Boiler E5-282C</p>	 <p>Gold Star E5-306-4 Gold Star E5-307-5</p>	 <p>Gordon Piatt E5-307W</p>
 <p>Fulton Boiler E5-283A</p>	 <p>Gordon Piatt E5-307A</p>	<p>Gould "A" E5-308 Gould 5" E5-309 Gould 6" E5-310 Gould 7" E5-311 Gould 8"</p>
 <p>Fulton Boiler E5-283B</p>	 <p>Gordon Piatt "A" E5-307B Gordon Piatt 5" E5-307C Gordon Piatt 7" E5-307D Gordon Piatt 9"</p>	 <p>Heil E5-330</p>
 <p>Fulton Boiler E5-284</p>	 <p>Gordon Piatt "A" E5-307F Gordon Piatt 4" E5-307G Gordon Piatt 5" E5-307H Gordon Piatt 6" E5-307H Gordon Piatt 8"</p>	 <p>Heil "A" E5-330A Heil 2-1/4" E5-330B Heil 4"</p>
 <p>Fulton Boiler E5-285</p>	 <p>Gordon Piatt "A" E5-307I Gordon Piatt 7-3/4" E5-307J Gordon Piatt 13-1/2"</p>	 <p>Heil "A" E5-331A Heil 5"</p>
 <p>General Automatic E5-290</p>	 <p>Gordon Piatt E5-307K</p>	 <p>Heil E5-331B</p>
 <p>General Electric E5-291</p>	 <p>Gordon Piatt "A" E5-307L Gordon Piatt 5-3/8" E5-307M</p>	 <p>Heil "A" E5-331C Heil 5" E5-331D</p>
 <p>General Electric E5-296</p>	 <p>Gordon Piatt "A" E5-307N Gordon Piatt 7-3/4" E5-307O Gordon Piatt 13-1/2"</p>	 <p>Homelite E5-337A</p>
 <p>General Electric E5-298</p>	 <p>Gordon Piatt "A" E5-307P Gordon Piatt 5" E5-307Q Gordon Piatt 2-3/4"</p>	 <p>Homestead E5-338</p>
 <p>General Electric E5-299</p>	 <p>Gordon Piatt "A" E5-307R Gordon Piatt 7" E5-307S Gordon Piatt 2"</p>	 <p>Hupp E5-339</p>
 <p>General Electric E5-299A</p>	 <p>Gordon Piatt "A" E5-307T Gordon Piatt 2-9/16" E5-307U Gordon Piatt 1-7/8"</p>	 <p>Hupp E5-339</p>
 <p>General Electric E5-300</p>	 <p>Gordon Piatt "A" E5-307V Gordon Piatt 2-9/16" E5-307W Gordon Piatt 1"</p>	 <p>Hupp E5-339</p>

Westwood electrodes & insulators

HIGH DIELECTRIC STRENGTH • PRECISION DIMENSIONS

Homestead E5-340	Iron Fireman E5-357D	Iron Fireman E5-363
Homestead E5-341	Iron Fireman E5-357E	Iron Fireman E5-364
Homestead E5-341A	Iron Fireman E5-357F	Iron Fireman E5-365
Industrial Combustion E5-342	Iron Fireman E5-357I	Iron Fireman E5-365B
Industrial Combustion E5-343	Iron Fireman E5-357J	Iron Fireman E5-365D
Industrial Combustion E5-343A	Iron Fireman E5-357K	Iron Fireman E5-366
Industrial Combustion E5-344	Iron Fireman E5-357L	Iron Fireman E5-366A
Industrial Combustion E5-344A	Iron Fireman E5-357M	Iron Fireman E5-366D
International E5-348	Iron Fireman E5-357N	Jet Heat E5-367
International E5-348A	Iron Fireman E5-357O	Johnson E5-371
		Johnson 1-1/2" E5-371A
International E5-349	Iron Fireman E5-357R	Johnson 2" E5-372
		Johnson 7-1/2" E5-374
Iron Fireman E5-356	Iron Fireman E5-357S	Johnson 6" E5-374
Iron Fireman E5-357	Iron Fireman E5-357U	Johnson E5-373
Iron Fireman E5-357A	Iron Fireman E5-357W	Johnson E5-373A
Iron Fireman E5-357B	Iron Fireman E5-357Y	Johnson E5-373B
Iron Fireman E5-357C	Iron Fireman E5-358	Johnson E5-375
		Johnson E5-375A

Please order by No.

ELECTRODES

Westwood electrodes & insulators

HIGH DIELECTRIC STRENGTH • PRECISION DIMENSIONS

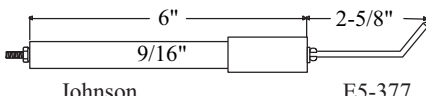
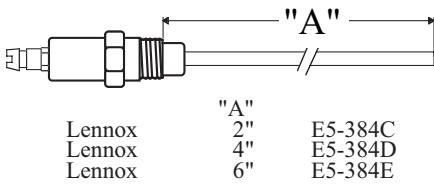
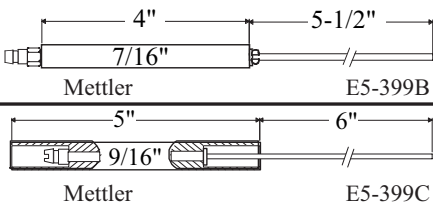
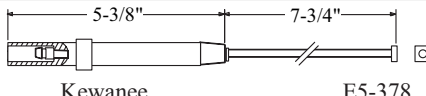
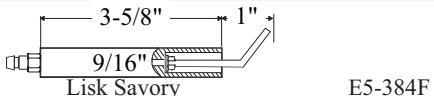
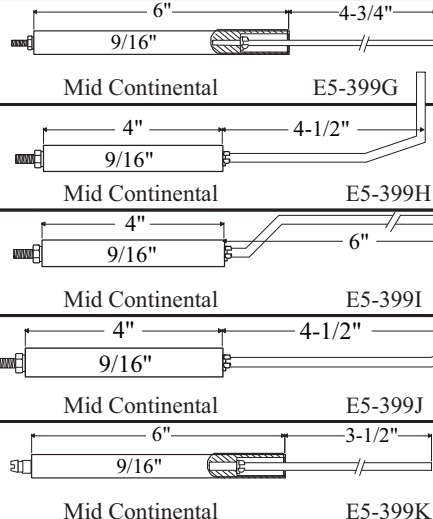
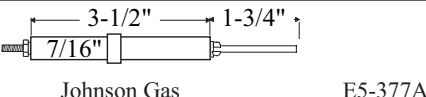
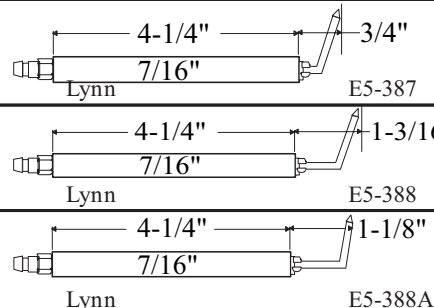
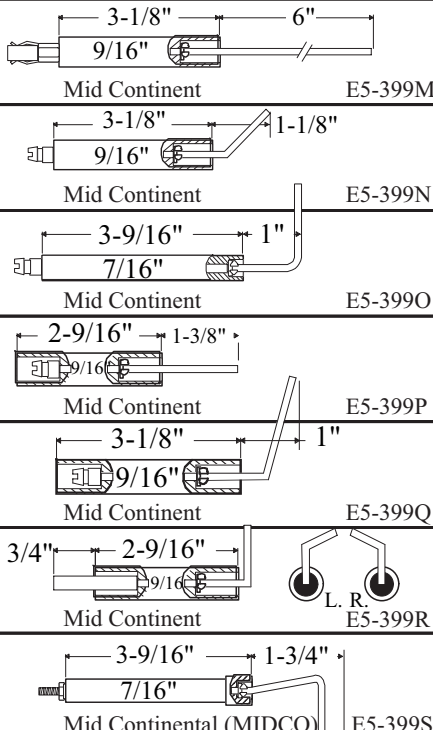
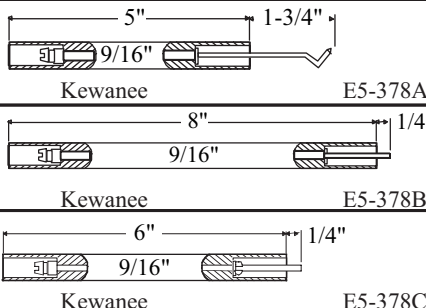
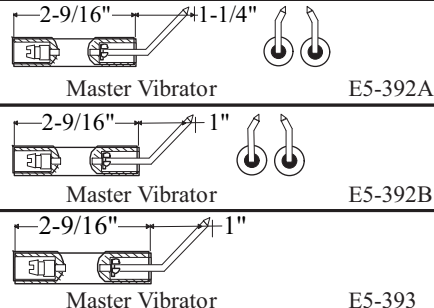
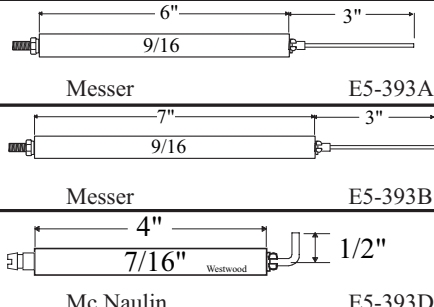
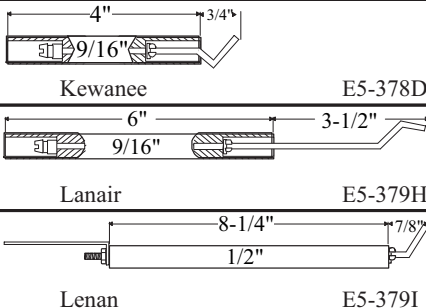
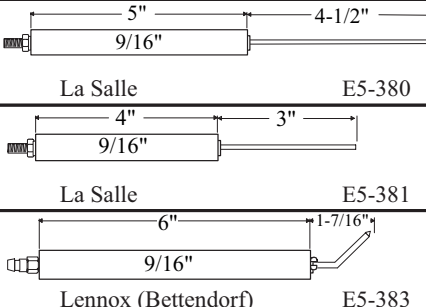
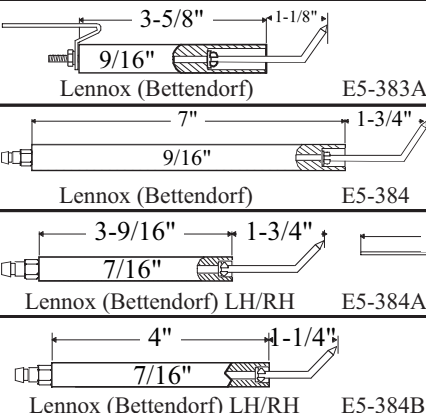
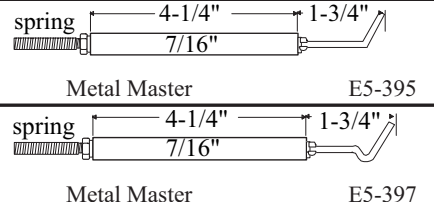
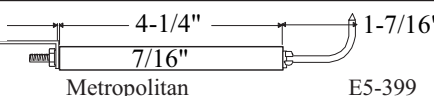
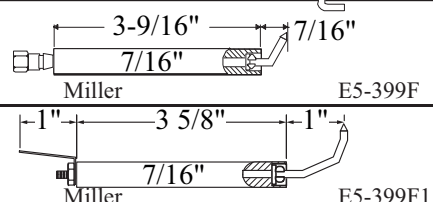
 <p>Johnson E5-377</p>	 <p>Lennox E5-384C Lennox E5-384D Lennox E5-384E</p>	 <p>Mettler E5-399B Mettler E5-399C</p>
 <p>Kewanee E5-378</p>	 <p>Lisk Savory E5-384F</p>	 <p>Mid Continental E5-399G Mid Continental E5-399H Mid Continental E5-399I Mid Continental E5-399J Mid Continental E5-399K Mid Continent E5-399L</p>
 <p>Johnson Gas E5-377A</p>	 <p>Lynn E5-387 Lynn E5-388 Lynn E5-388A</p>	 <p>Mid Continent E5-399M Mid Continent E5-399N Mid Continent E5-399O Mid Continent E5-399P Mid Continent E5-399Q Mid Continent E5-399R Mid Continental (MIDCO) E5-399S</p>
 <p>Kewanee E5-378A Kewanee E5-378B Kewanee E5-378C Kewanee E5-378D</p>	 <p>Master Vibrator E5-392A Master Vibrator E5-392B Master Vibrator E5-393</p>	 <p>Messer E5-393A Messer E5-393B Mc Naulin E5-393D</p>
 <p>Lanair E5-379H Lenan E5-379I</p>	 <p>La Salle E5-380 La Salle E5-381</p>	 <p>Lennox (Bettendorf) E5-383 Lennox (Bettendorf) E5-383A Lennox (Bettendorf) E5-384 Lennox (Bettendorf) LH/RH E5-384A Lennox (Bettendorf) LH/RH E5-384B</p>
 <p>spring Metal Master E5-395 spring Metal Master E5-397</p>	 <p>Metropolitan E5-399</p>	 <p>Miller E5-399F Miller E5-399F1</p>

Westwood electrodes & insulators

HIGH DIELECTRIC STRENGTH • PRECISION DIMENSIONS

<p>Miller E5-400A</p>	<p>M&H (with Bracket) E5-409C-2</p>	<p>Nu-Way E5-418F</p>
<p>MSO Combustion E5-390</p>	<p>M&H E5-409E</p>	<p>Nu-Way E5-419</p>
<p>MSO Combustion E5-391</p>	<p>M&H E5-409F</p>	<p>Nu-Way E5-420</p>
<p>Monarch E5-400</p>	<p>M&H E5-409G</p>	<p>Nu-Way E5-420A</p>
<p>Mueller E5-401</p>	<p>M&H E5-409H</p>	<p>Nu-Way E5-420A1</p>
<p>Morrison E5-404</p>	<p>M&H E5-409J</p>	<p>Nu-Way E5-420B</p>
<p>Mt Hawley E5-405</p>	<p>M&H E5-409K</p>	<p>Nu-Way E5-420C</p>
<p>Mt Hawley RH/LH E5-406A</p>	<p>National Airol E5-411</p>	<p>Nu-Way E5-421</p>
<p>M&H E5-407</p>	<p>National Airol E5-412</p>	<p>Nu-Way E5-425</p>
<p>M&H E5-407A</p>	<p>National Airol E5-415</p>	<p>Nu-Way E5-428</p>
<p>M&H E5-408</p>	<p>National Airol E5-416</p>	<p>Nu-Way E5-429</p>
<p>M&H E5-409</p>	<p>Northeast E5-417</p>	<p>Nu-Way E5-429H</p>
<p>M&H E5-409A</p>	<p>Nu-Way E5-418</p>	<p>Nu-Way E5-429A</p>
<p>M&H E5-409B</p>	<p>Nu-Way E5-418A</p>	<p>Nu-Way E5-429B 1/2" E5-429E 2"</p> <p>Nu-Way E5-429C 1-1/2" E5-429F 2-1/2"</p> <p>Nu-Way E5-429D 2" E5-429G 3-1/2"</p> <p>Nu-Way E5-430</p>
<p>M&H E5-409C</p>	<p>Nu-Way E5-418B</p>	<p>Nu-Way E5-430A</p>
<p>M&H E5-409D</p>		

Please order by  No.

ELECTRODES

Westwood electrodes & insulators

HIGH DIELECTRIC STRENGTH • PRECISION DIMENSIONS

<p>Oil Equipment E5-432</p>	<p>Petro 1-1/2" E5-468B Petro 2" E5-468C Petro 18" E5-468D</p>	<p>Power Flame E5-477I</p>
<p>Orr & Sembower E5-443</p>	<p>Power Flame E5-477J</p>	<p>Power Flame E5-477K</p>
<p>Orr & Sembower E5-448</p>	<p>Power Flame E5-475</p>	<p>Power Flame E5-478</p>
<p>Orr & Sembower E5-449</p>	<p>Power Flame E5-475A</p>	<p>Power Flame E5-478A</p>
<p>Orr & Sembower E5-451</p>	<p>Power Flame E5-475B</p>	<p>Power Flame E5-478B</p>
<p>Orr & Sembower E5-452</p>	<p>Power Flame E5-477</p>	<p>Power Flame E5-478C</p>
<p>Orr & Sembower E5-453</p>	<p>Power Flame E5-478D</p>	<p>Power Flame E5-478E</p>
<p>Peabody E5-457</p>	<p>Power Flame 5.81" .50" E5-477A Power Flame 6.44" .38" E5-477B Power Flame 6.88" .47" E5-477C</p>	<p>Power Flame E5-479</p>
<p>Peabody E5-458</p>	<p>Power Flame 5.81" 6.30" E5-477A-1 Power Flame 6.44" 6.69" E5-477B-1 Power Flame 6.88" 8.66" E5-477C-1</p>	<p>Power Flame E5-479A</p>
<p>Penn Boiler E5-461</p>	<p>Power Flame E5-477D</p>	<p>Power Flame E5-479B</p>
<p>Petro E5-465</p>	<p>Power Flame E5-477E</p>	<p>Power Flame E5-479C</p>
<p>Petro E5-465B</p>	<p>Power Flame E5-477F</p>	<p>Power Flame E5-479D</p>
<p>Petro E5-466</p>	<p>Power Flame E5-477G</p>	<p>Power Flame E5-479E</p>
<p>Petro 1-1/2" E5-467 Petro 2" E5-467A Petro 18" E5-467B Petro 6" E5-467G</p>	<p>Power Flame E5-477H</p>	<p>Power Flame E5-479E1</p>
<p>Petro E5-468A</p>		

Westwood electrodes & insulators

HIGH DIELECTRIC STRENGTH • PRECISION DIMENSIONS



<p>Preferred Utilities E5-471A</p>	<p>Ray E5-502</p>	<p>Light Tip</p>																																	
<p>PVI E5-473F</p>	<p>Ray E5-503A</p>	<table border="0"> <tr><td>Shellhead</td><td>4"</td><td>E5-513-4</td></tr> <tr><td>Shellhead</td><td>5"</td><td>E5-513-5</td></tr> <tr><td>Shellhead</td><td>6"</td><td>E5-513-6</td></tr> <tr><td>Shellhead</td><td>7"</td><td>E5-513-7</td></tr> <tr><td>Shellhead</td><td>8"</td><td>E5-513-8</td></tr> <tr><td>Shellhead</td><td>9"</td><td>E5-513-9</td></tr> <tr><td>Shellhead</td><td>10"</td><td>E5-513-10</td></tr> <tr><td>Shellhead</td><td>11"</td><td>E5-513-11</td></tr> <tr><td>Shellhead</td><td>12"</td><td>E5-513-12</td></tr> <tr><td>Shellhead</td><td>13"</td><td>E5-513-13</td></tr> <tr><td>Shellhead</td><td>14"</td><td>E5-513-14</td></tr> </table>	Shellhead	4"	E5-513-4	Shellhead	5"	E5-513-5	Shellhead	6"	E5-513-6	Shellhead	7"	E5-513-7	Shellhead	8"	E5-513-8	Shellhead	9"	E5-513-9	Shellhead	10"	E5-513-10	Shellhead	11"	E5-513-11	Shellhead	12"	E5-513-12	Shellhead	13"	E5-513-13	Shellhead	14"	E5-513-14
Shellhead	4"	E5-513-4																																	
Shellhead	5"	E5-513-5																																	
Shellhead	6"	E5-513-6																																	
Shellhead	7"	E5-513-7																																	
Shellhead	8"	E5-513-8																																	
Shellhead	9"	E5-513-9																																	
Shellhead	10"	E5-513-10																																	
Shellhead	11"	E5-513-11																																	
Shellhead	12"	E5-513-12																																	
Shellhead	13"	E5-513-13																																	
Shellhead	14"	E5-513-14																																	
<p>PVI E5-473G</p>	<p>Ray E5-503D</p>																																		
<p>Pyronics E5-474C-1 6" E5-474C-2 12"</p>	<p>Ray E5-503E</p>																																		
<p>Pyronics E5-474E</p>	<p>Ray E5-503F</p>	<p>Heavy Tip</p>																																	
<p>Quiet Automatic E5-480</p>	<p>Ray E5-503G</p>	<table border="0"> <tr><td>Shellhead</td><td>4"</td><td>E5-514-4</td></tr> <tr><td>Shellhead</td><td>5"</td><td>E5-514-5</td></tr> <tr><td>Shellhead</td><td>6"</td><td>E5-514-6</td></tr> <tr><td>Shellhead</td><td>7"</td><td>E5-514-7</td></tr> <tr><td>Shellhead</td><td>8"</td><td>E5-514-8</td></tr> <tr><td>Shellhead</td><td>9"</td><td>E5-514-9</td></tr> <tr><td>Shellhead</td><td>10"</td><td>E5-514-10</td></tr> <tr><td>Shellhead</td><td>11"</td><td>E5-514-11</td></tr> <tr><td>Shellhead</td><td>12"</td><td>E5-514-12</td></tr> <tr><td>Shellhead</td><td>13"</td><td>E5-514-13</td></tr> <tr><td>Shellhead</td><td>14"</td><td>E5-514-14</td></tr> </table>	Shellhead	4"	E5-514-4	Shellhead	5"	E5-514-5	Shellhead	6"	E5-514-6	Shellhead	7"	E5-514-7	Shellhead	8"	E5-514-8	Shellhead	9"	E5-514-9	Shellhead	10"	E5-514-10	Shellhead	11"	E5-514-11	Shellhead	12"	E5-514-12	Shellhead	13"	E5-514-13	Shellhead	14"	E5-514-14
Shellhead	4"	E5-514-4																																	
Shellhead	5"	E5-514-5																																	
Shellhead	6"	E5-514-6																																	
Shellhead	7"	E5-514-7																																	
Shellhead	8"	E5-514-8																																	
Shellhead	9"	E5-514-9																																	
Shellhead	10"	E5-514-10																																	
Shellhead	11"	E5-514-11																																	
Shellhead	12"	E5-514-12																																	
Shellhead	13"	E5-514-13																																	
Shellhead	14"	E5-514-14																																	
<p>Quiet Heet 4-1/4" E5-483 Quiet Heet 5" E5-483-5 Quiet Heet 6" E5-483-6</p>	<p>Ray E5-503H</p>	<p>Light Tip</p>																																	
<p>Radiant E5-490</p>	<p>Ray E5-503I</p>	<table border="0"> <tr><td>Shellhead</td><td>5"</td><td>E5-515-5</td></tr> <tr><td>Shellhead</td><td>6"</td><td>E5-515-6</td></tr> <tr><td>Shellhead</td><td>7"</td><td>E5-515-7</td></tr> <tr><td>Shellhead</td><td>8"</td><td>E5-515-8</td></tr> </table>	Shellhead	5"	E5-515-5	Shellhead	6"	E5-515-6	Shellhead	7"	E5-515-7	Shellhead	8"	E5-515-8																					
Shellhead	5"	E5-515-5																																	
Shellhead	6"	E5-515-6																																	
Shellhead	7"	E5-515-7																																	
Shellhead	8"	E5-515-8																																	
<p>Rails E5-489B</p>	<p>Ray E5-503J</p>	<p>Heavy Tip</p>																																	
<p>Rails E5-489C</p>	<p>Ray E5-503K</p>	<table border="0"> <tr><td>Shellhead</td><td>5"</td><td>E5-516-5</td></tr> <tr><td>Shellhead</td><td>6"</td><td>E5-516-6</td></tr> </table>	Shellhead	5"	E5-516-5	Shellhead	6"	E5-516-6																											
Shellhead	5"	E5-516-5																																	
Shellhead	6"	E5-516-6																																	
<p>Rasol E5-494</p>	<p>Ray E5-503L</p>	<p>Light Tip</p>																																	
<p>Ray E5-499 3-3/4" E5-499C 5"</p>	<p>Robert Gordon E5-506B</p>	<table border="0"> <tr><td>Silent Glow</td><td>3"</td><td>E5-523</td></tr> <tr><td>Silent Glow</td><td>4"</td><td>E5-524</td></tr> <tr><td>Silent Glow</td><td>5"</td><td>E5-525</td></tr> <tr><td>Silent Glow</td><td>6"</td><td>E5-526</td></tr> <tr><td>Silent Glow</td><td>11-3/4"</td><td>E5-527</td></tr> </table>	Silent Glow	3"	E5-523	Silent Glow	4"	E5-524	Silent Glow	5"	E5-525	Silent Glow	6"	E5-526	Silent Glow	11-3/4"	E5-527																		
Silent Glow	3"	E5-523																																	
Silent Glow	4"	E5-524																																	
Silent Glow	5"	E5-525																																	
Silent Glow	6"	E5-526																																	
Silent Glow	11-3/4"	E5-527																																	
<p>Ray E5-499D</p>	<p>Robert Gordon E5-506C</p>	<p>Silent Glow E5-523A</p>																																	
<p>Ray E5-500</p>	<p>Sandberg E5-510</p>	<p>Stewart Warner E5-545</p>																																	
<p>Ray E5-501</p>	<p>Scully Fastlite E5-512A</p>	<p>Stewart Warner E5-545A</p>																																	

Please order by No.

ELECTRODES

Westwood electrodes & insulators

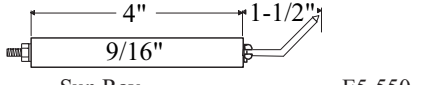
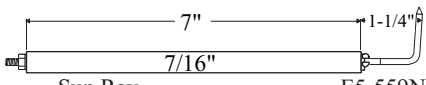
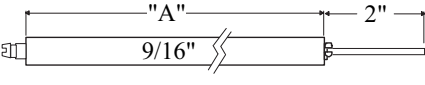
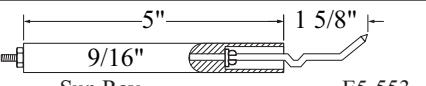
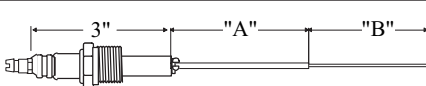
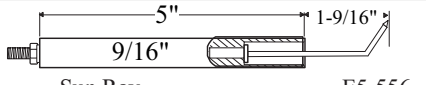
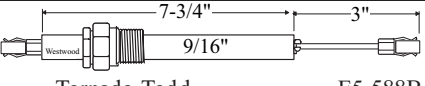
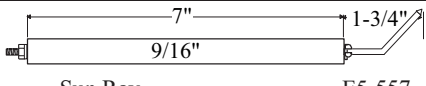
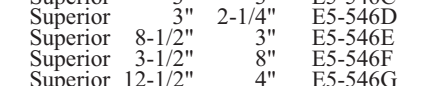
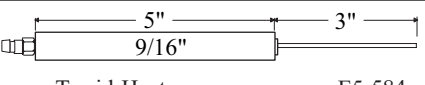
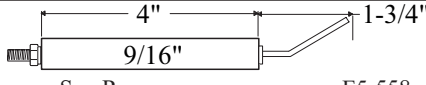
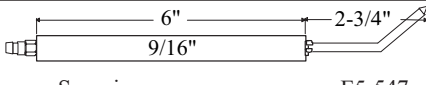
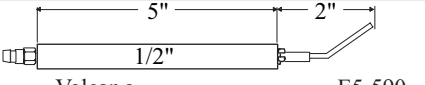
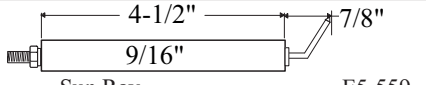
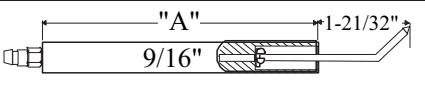
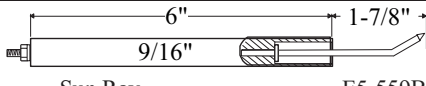
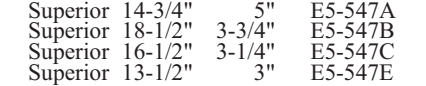
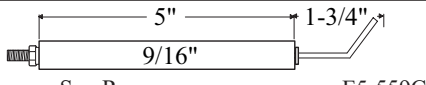
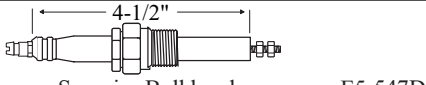
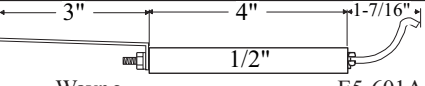
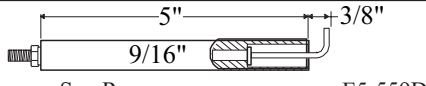
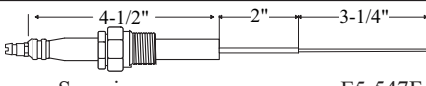
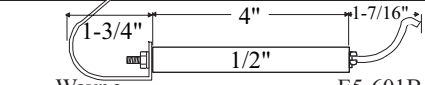
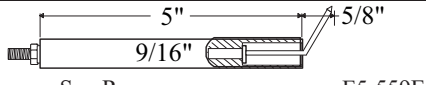
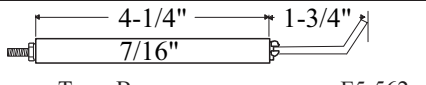
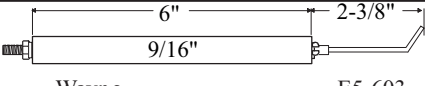
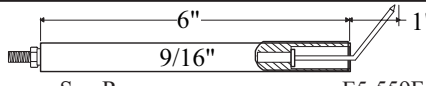
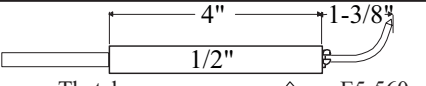
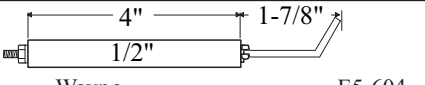
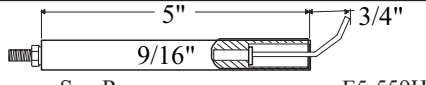
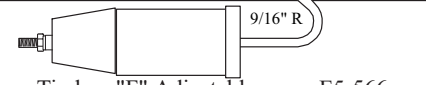
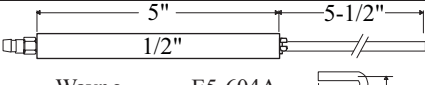
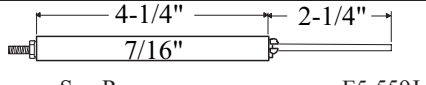
HIGH DIELECTRIC STRENGTH • PRECISION DIMENSIONS

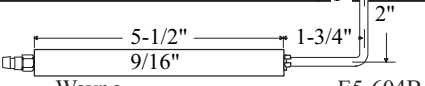
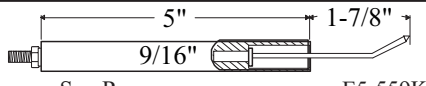
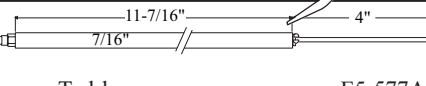
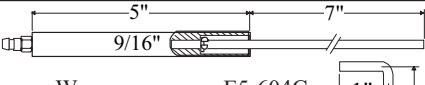
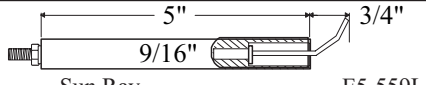
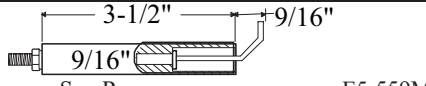
 Sun Ray E5-550	 Sun Ray E5-559N	
 Sun Ray E5-553		Todd "A" Todd 8-3/4" E5-578 Todd 10-1/4" E5-578A Todd 12" E5-579 Todd 14" E5-580 Todd 17" E5-581 Todd 19" E5-582 Todd 21" E5-582A Todd 23" E5-582B Todd 24" E5-582C
 Sun Ray E5-556	Superior "A" "B" Superior 3-1/2" 4-1/2" E5-546 Superior 4-1/2" 6" E5-546A Superior 10-1/4" 5" E5-546B Superior 3" 3" E5-546C Superior 3" 2-1/4" E5-546D Superior 8-1/2" 3" E5-546E Superior 3-1/2" 8" E5-546F Superior 12-1/2" 4" E5-546G	 Tornado Todd E5-588B
 Sun Ray E5-557	 Superior E5-547	 Torrid Heat E5-584
 Sun Ray E5-558		 Volcano E5-590
 Sun Ray E5-559	Superior "A" "B" Superior 14-3/4" 5" E5-547A Superior 18-1/2" 3-3/4" E5-547B Superior 16-1/2" 3-1/4" E5-547C Superior 13-1/2" 3" E5-547E	
 Sun Ray E5-559B	 Superior Bulkhead E5-547D	Waltham 3-1/2" E5-600-3 Waltham 4" E5-600-4 Waltham 5" E5-600-5 Waltham 6" E5-600-6
 Sun Ray E5-559C	 Superior E5-547F	 Wayne E5-601A
 Sun Ray E5-559D	 Terry Burner E5-562	 Wayne E5-601B
 Sun Ray E5-559E	 Thatcher E5-560	 Wayne E5-603
 Sun Ray E5-559F	 Timken "F" Adjustable E5-566	 Wayne E5-604
 Sun Ray E5-559H	 Timken "C" Adjustable E5-567	 Wayne E5-604A
 Sun Ray E5-559J	 Todd E5-577A	 Wayne E5-604B
 Sun Ray E5-559K	 Wayne E5-604C	 Wayne E5-604D
 Sun Ray E5-559L	Todd "A" Todd 9/16" E5-579A Todd 13" E5-579B Todd 16" E5-579C Todd 19" E5-579D Todd 21" E5-579E Todd 22" E5-579F	
 Sun Ray E5-559M		

Westwood electrodes & insulators

HIGH DIELECTRIC STRENGTH • PRECISION DIMENSIONS

 Wayne E5-605	 Waywolf E5-606A	 York E5-631C	
 Wayne E5-605A	 Webster Engineering E5-599E	 York E5-632	
 Wayne E5-605B	 Webster Engineering E5-599F	 York E5-632A	
 Wayne E5-605C	 Webster Engineering E5-599G	 York E5-632B	
 Wayne E5-605D	 Weil-McLain, electrode only E5-598 Weil-McLain electrode w/leads E5-598A Leads only (former WMK-150) E5-598B	 York E5-632C	
 Wayne E5-605E		 York E5-632D	
 Wayne Blue Angel E5-605F		 York E5-632E	
 Wayne Blue Angel E5-605F1 Wayne (with pointed tip) E5-605F2		 York E5-633	
 Wayne E5-605G		 White Rodgers E5-607A	 York E5-634
 Wayne E5-605H		 Williams E5-624	 York E5-634A
 Wayne E5-605I	 John Wood E5-621	 York (Levittown) E5-635	
 Wayne E5-605J	 John Wood E5-623	 York E5-636	
 Wayne E5-605K	 York E5-637	 York E5-638	
 Wayne E5-605L	 York 'A' E5-630 York 'A' 4 inch E5-631 York 'A' 5 inch E5-631	 York E5-639	
 Wayne E5-605M	 York E5-640	 York E5-641	
 Wayne E5-605N	 York 'A' 4 inch E5-629 York 'A' 4 inch 6 inch E5-630A York 'A' 5 inch 6 inch E5-631A York 'A' 5 inch 2 inch E5-631B	 York E5-640	
 Wayne E5-605P	 York 'A' 4 inch E5-629 York 'A' 4 inch 6 inch E5-630A York 'A' 5 inch 6 inch E5-631A York 'A' 5 inch 2 inch E5-631B	 York E5-640	
 Wayne E5-606	 York 'A' 4 inch E5-629 York 'A' 4 inch 6 inch E5-630A York 'A' 5 inch 6 inch E5-631A York 'A' 5 inch 2 inch E5-631B	 York E5-640	

Please order by No.

Take a look ...

BURNER TUNE-UP KITS in Service Supplies Section pages S7 - S8

rev. 5-1-05

E14

ELECTRODE KITS

Westwood

ELECTRODE KITS

FOR THE SERVICE PROFESSIONAL

**ELECTRODE & INSULATOR KITS****Serviceman's Deluxe Kit****OEM Electrodes - 2 ea.**

ABC: E5-146

Beckett: E5-151E, E5-151O

Carlin: E5-188B, E5-188N, 5-188K

Quiet Heat: E5-483

Wayne: E5-604, E5-605, E5-605B,
E5-605F, E5-606**Rajah™ Terminals - 10 ea.**

E5-CT, E5-SS, E5-R-2, E5-RAC, E5-SF,

E5-ET, E5-BS 6-32, E5-BS 10-32,

E5-HS 6-32 (5 ea.), E5-HS 10-32 (5 ea.),
6-32 nut, 10-32 nut**Standard Electrodes - 2 ea.**E5-1M4, E5-2M4, E5-2M5, E5-2M6,
E5-4M4, E5-3M4, E5-3M5, E5-3M6**Also includes**

5 feet of GTO-15 ignition cable

1 set (2) T100-230 electrode benders

1 - T100-220 electrode gauge

1 set (2) T100-70 jumpers

1 - NAS gauge™ nozzle gauge

1 - Coupler Popper™ tool

1 - Plastic carrying case

 No. E5-2001
Serviceman's Super Kits

Same contents as the E5-2001 Deluxe Kit, less the NAS gauge™ and Coupler Popper™
in a plastic carrying case

 No. E5-1897

Same contents as the E5-2001 Deluxe Kit, less the NAS gauge™ and Coupler Popper™
in a cardboard box

 No. E5-1897-C
ELECTRODE & INSULATOR ROLL-UP KITS**Contains:****Electrodes - 2 ea.**

E5-3M4 (9/16"x4"), E5-3M5 (9/16"x5"),

E5-3M6 (9/16"x6"), E5-3F5 (9/16"x5"),

E5-483 (Quiet Heat)

Insulators - 2 ea.

E5-1M4-1/4 (7/16"x4-1/4"), E5-4M4 (1/2"x4"),

E5-2M4 (9/16"x4"), E5-2M5 (9/16"x5"),

E5-3M4 (9/16"x4")

 No. E5-595
Contains:**Electrodes - 2 ea.**

E5-188N (Carlin), E5-151E (Beckett),

E5-605 (Wayne), E5-2M4 (9/16"x4"),

E5-2M5 (9/16"x5"), E5-2M6 (9/16"x6"),

E5-2F5 (female 5"), E5-2F6 (female 6")

Insulators - 2 ea.

E5-1M4-1/4 (7/16"x4-1/4"), E5-3M4 (9/16"x4"),

E5-2M4 (9/16"x4"), E5-2M5 (9/16"x5"),

E5-2M6 (9/16"x6"), E5-2F5 (female 5"),

E5-2F6 (female 6"), E5-4M4 (1/2"x4")

 No. E5-920

Westwood

ELECTRODE KITS



FOR THE SERVICE PROFESSIONAL

**ELECTRODE & INSULATOR ROLL-UP KITS (Continued)**

For Servicing
Beckett Burners

Contains these electrodes:

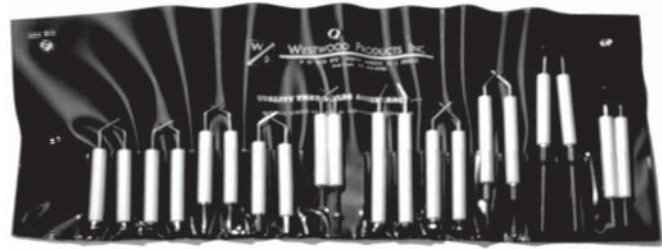

4 · E5-151E	2 · E5-151D
2 · E5-151E1	2 · E5-151R
2 · E5-151O	2 · E5-151G
2 · E5-151F	2 · E5-151J
2 · E5-151	

 No. E5-BK-400

For Servicing
Carlin Burners

Contains these electrodes:

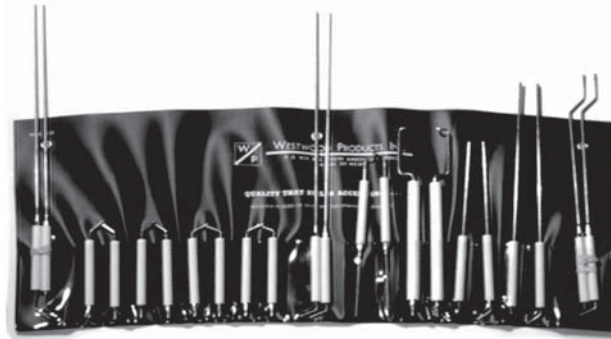
4 · E5-188N	2 · E5-188P
4 · E5-188B	2 · E5-188Q
2 · E5-188K	2 · E5-188R3
2 · E5-188R-2	2 · E5-188N4
2 · E5-188H	

 No. E5-CK-300

For Servicing
Wayne Burners

Contains these electrodes:

4 · E5-605	2 · E5-605E
4 · E5-606	2 · E5-605C
2 · E5-605B	2 · E5-605D
2 · E5-605F	2 · E5-605F1
2 · E5-604	

 No. E5-WK-500

 Take a look . . .

PORCELAIN CUTTER No. T100-370 on page T16
&
RAJAH TERMINAL KITS on page E33

Please order by  No.

AUBURN ELECTRODES

Westwood

AUBURN IGNITION PRODUCTS

IGNITORS • FLAME RODS • LIQUID LEVEL ELECTRODES

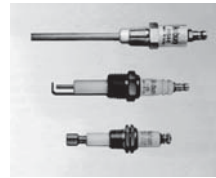

NOTE: Auburn ignition products part numbers are now "E5-" followed by the former number.

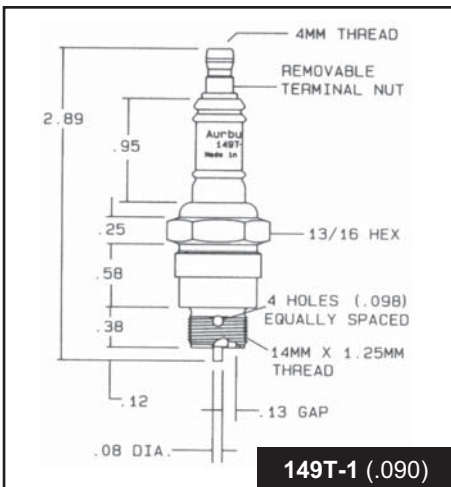
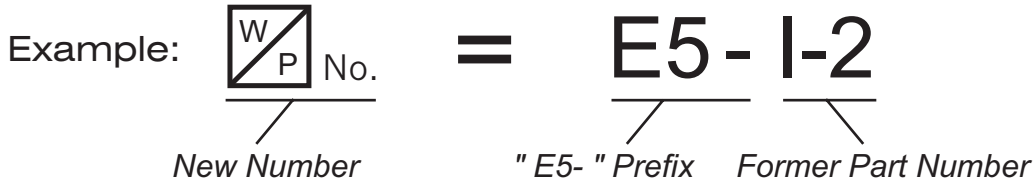

149T-1 (.090)

 No.	Ref. No.
E5-149T-1-090	149T-1-090

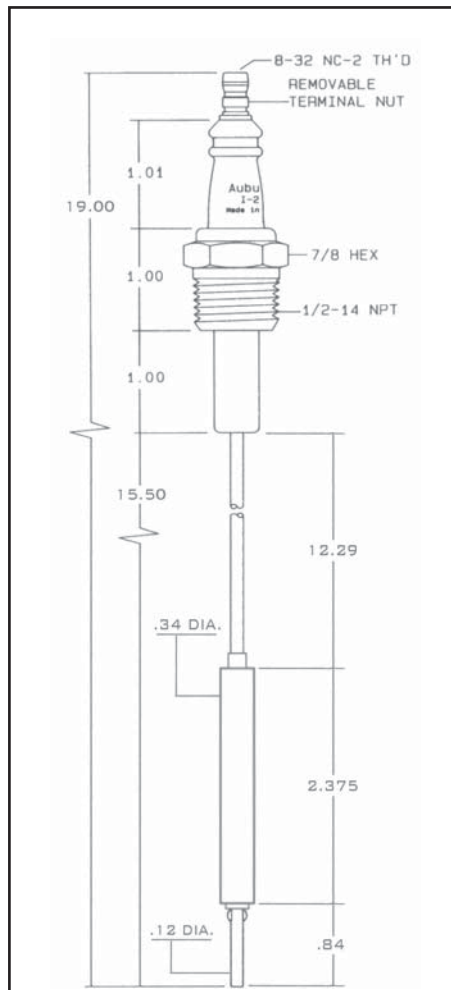

I-2-EI-2

 No.	Ref. No.
E5-I-2-EI-2	I-2-EI-2

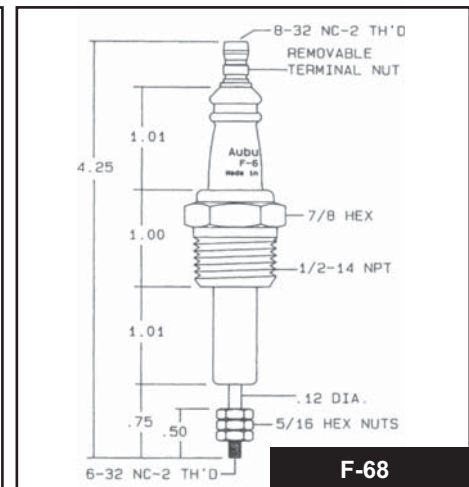

F-68

 No.	Ref. No.
E5-F-68	F-68

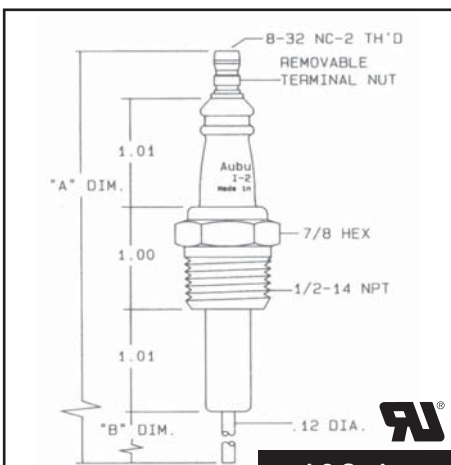

I-2 Series

 No.	Ref. No.	"A" DIM.	"B" DIM.
E5-I-2	I-2	8.00	4.50
E5-I-2-1	I-2-1	15.50	12.00
E5-I-2-2	I-2-2	27.50	24.00

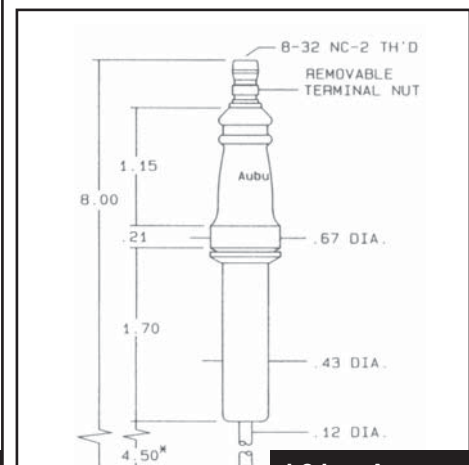

I-2 Ins. Assem.

 No.	Ref. No.
E5-I-2 Ins Asy	I-2 Ins Asy

* Dimensions marked with an asterisk are standard lengths - Other lengths available upon request

AUBURN ELECTRODES

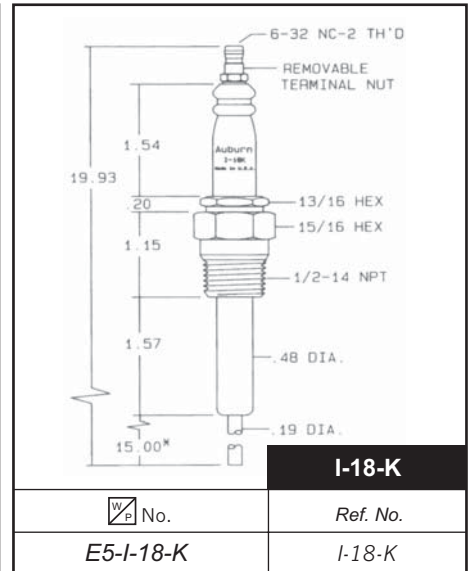
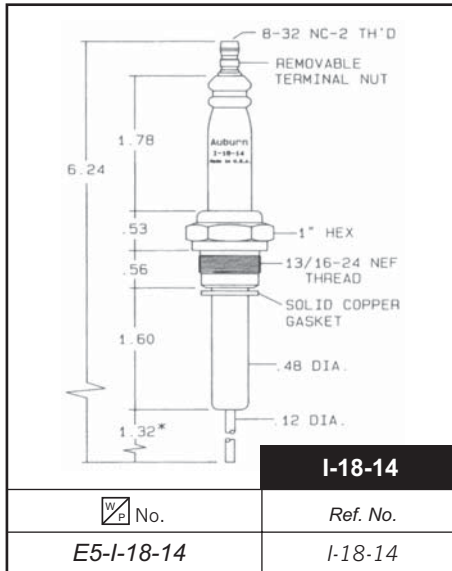
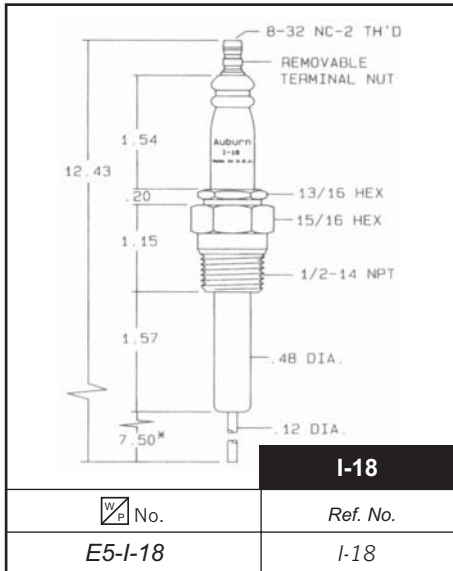
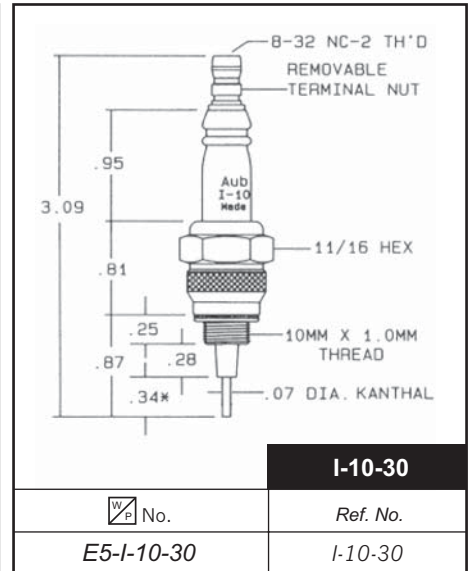
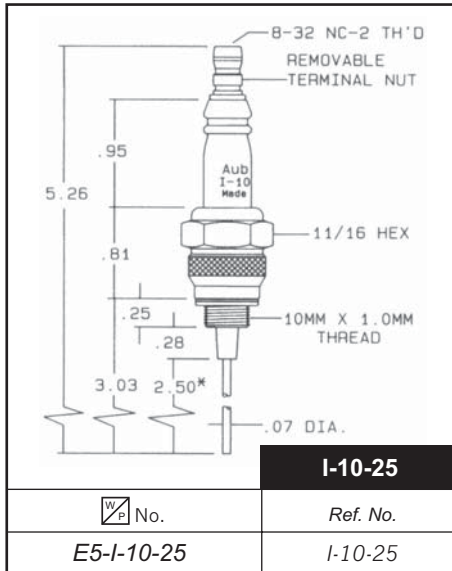
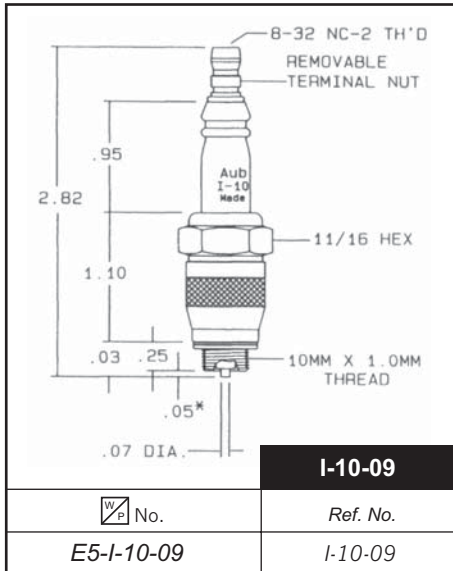
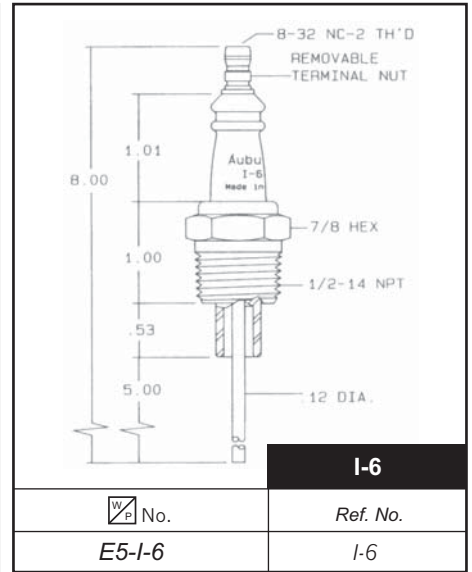
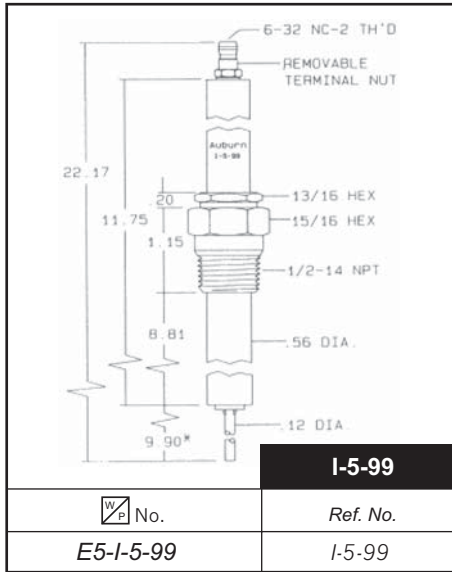
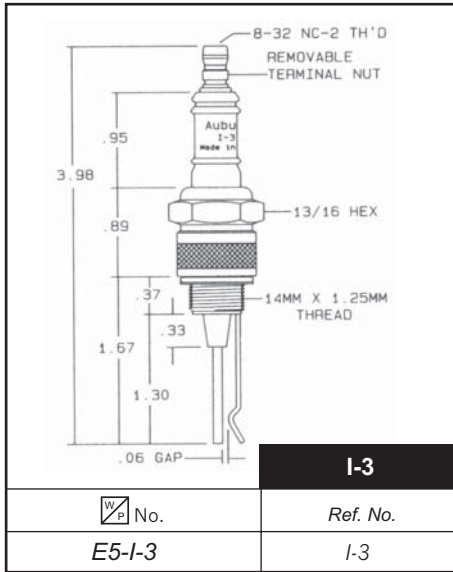

* Dimensions marked with an asterisk are standard lengths - Other lengths available upon request

Please order by No.

AUBURN ELECTRODES

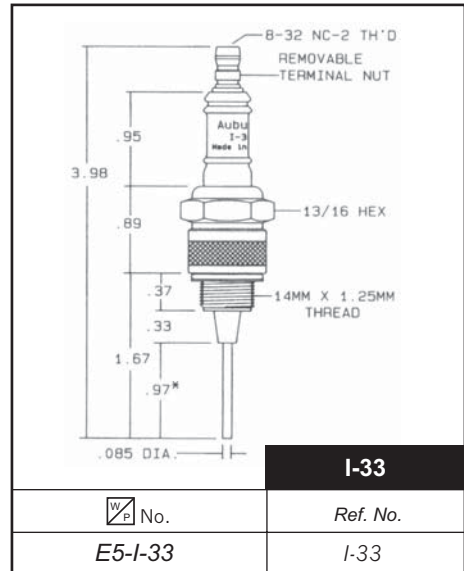
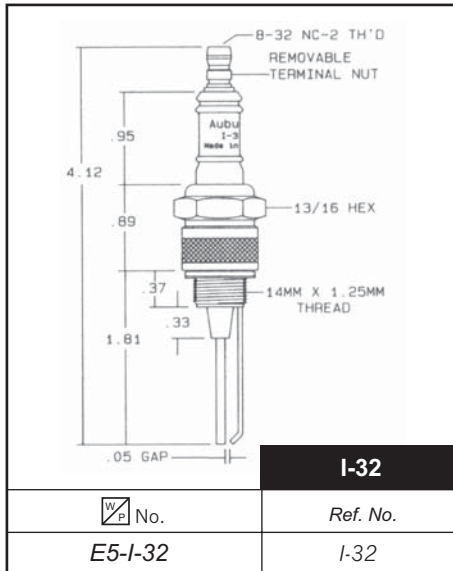
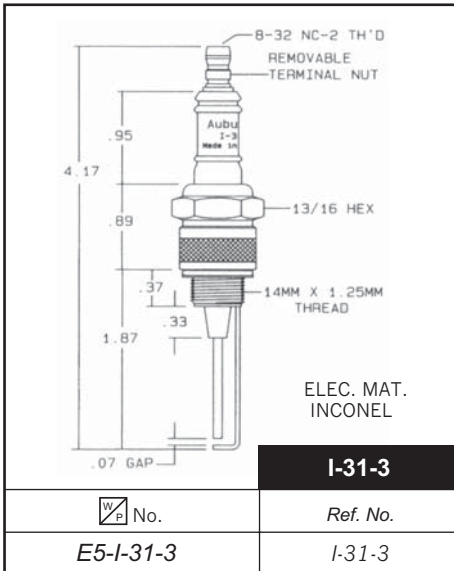
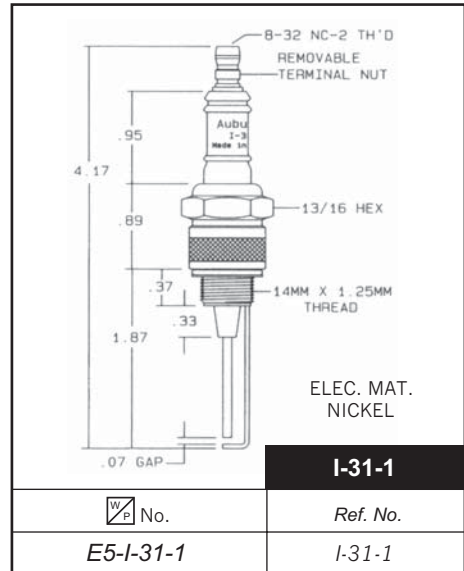
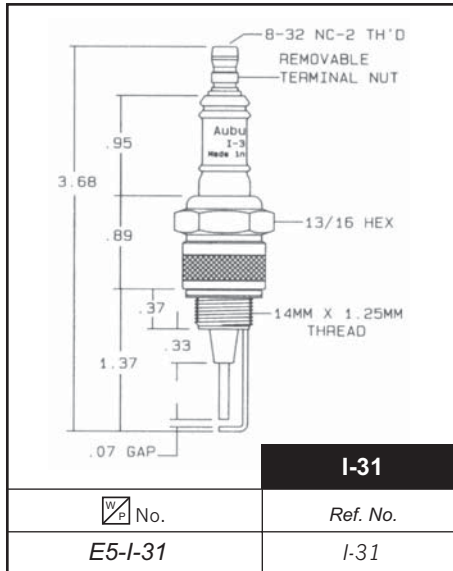
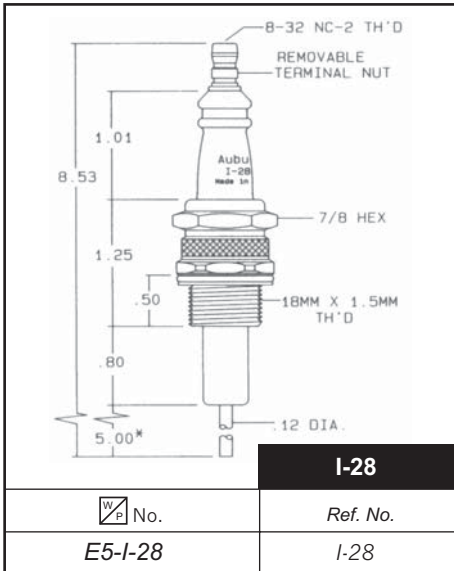
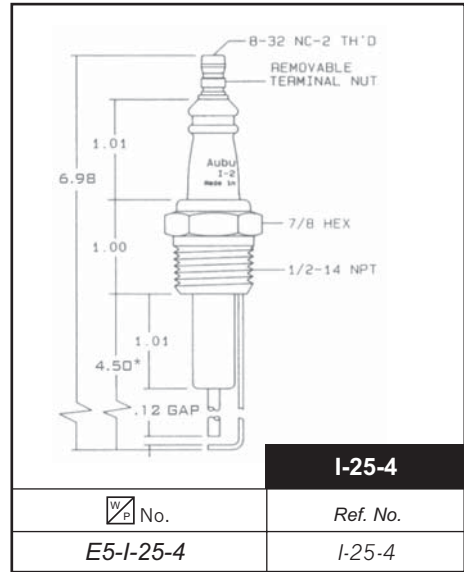
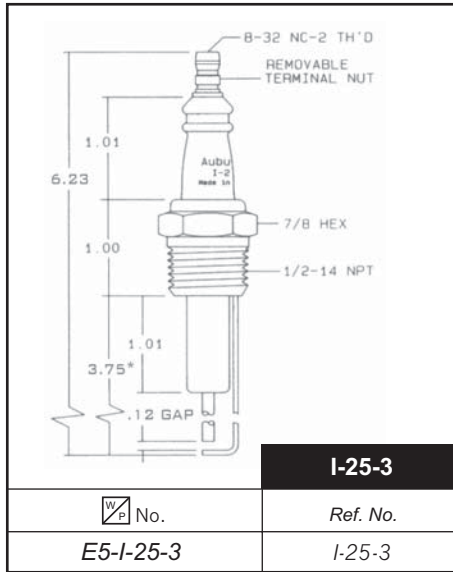
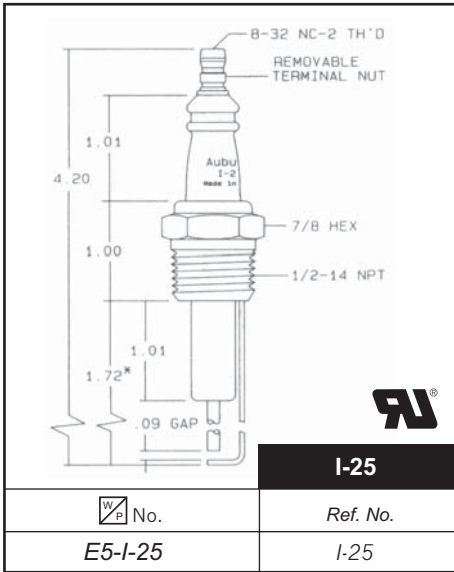

* Dimensions marked with an asterisk are standard lengths - Other lengths available upon request

AUBURN ELECTRODES

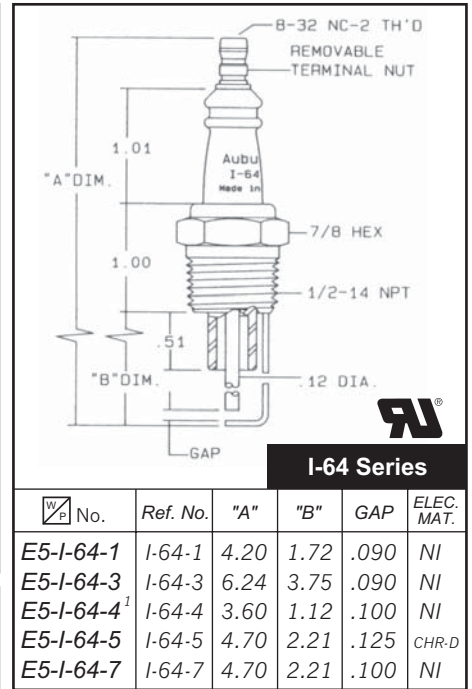
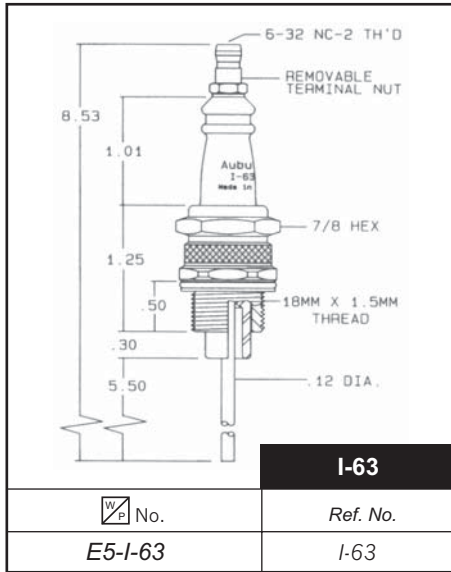
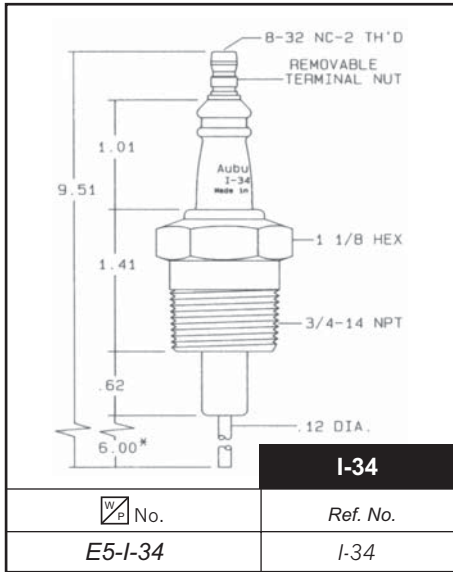

¹UL Recognized Component

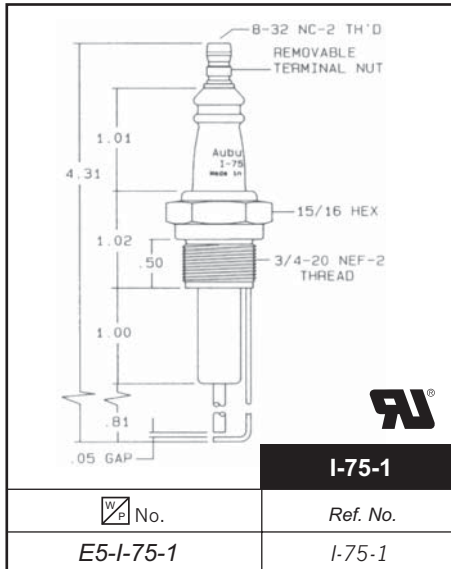
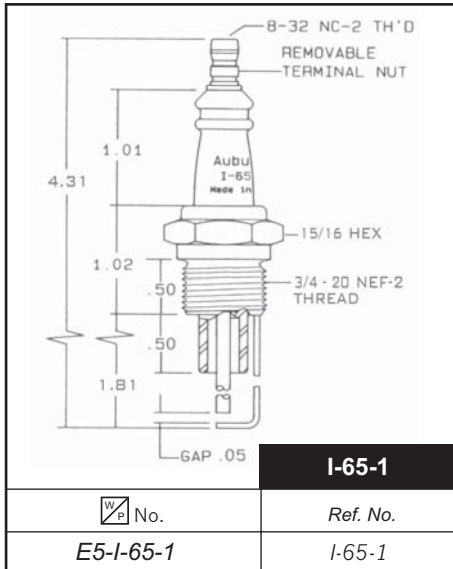

As a major distributor of Auburn Ignition Products, Westwood can special order any Auburn item not shown in this catalog and get it to you fast!

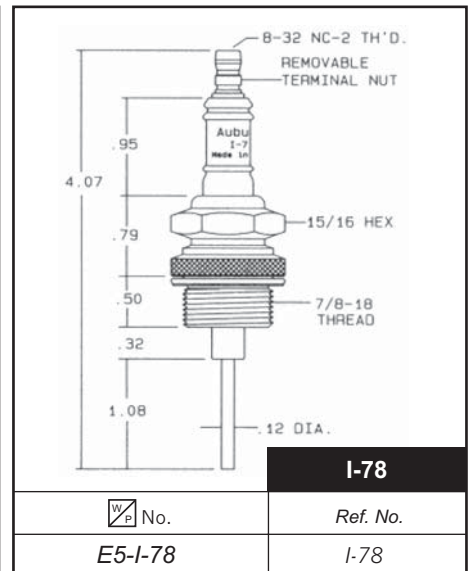
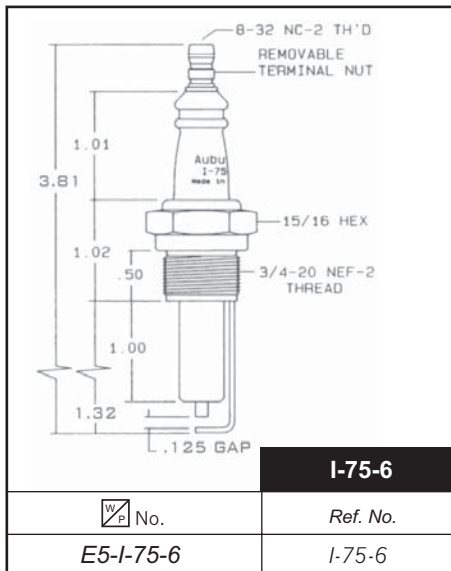
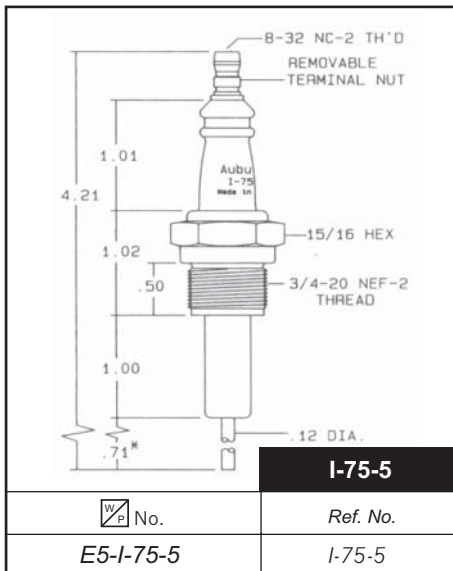

* Dimensions marked with an asterisk are standard lengths - Other lengths available upon request

Please order by No.

AUBURN ELECTRODES

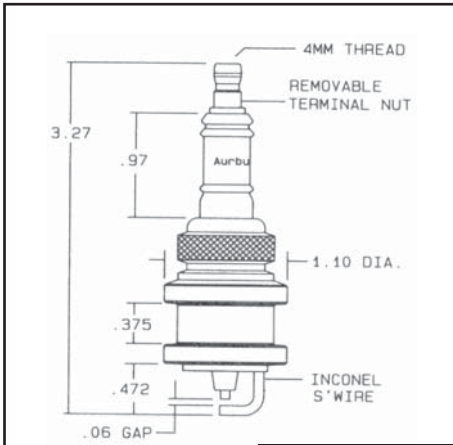

I-82

No.	Ref. No.
E5-I-82	I-82

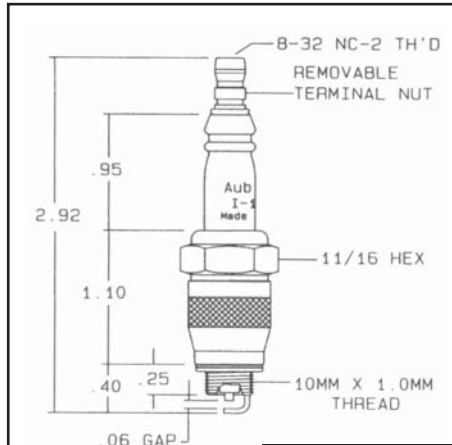

I-101

No.	Ref. No.
E5-I-101	I-101

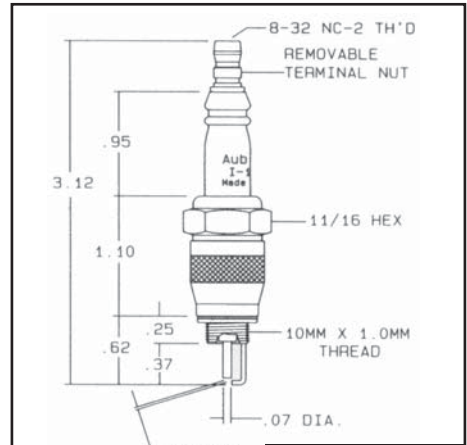

I-102

No.	Ref. No.
E5-I-102	I-102

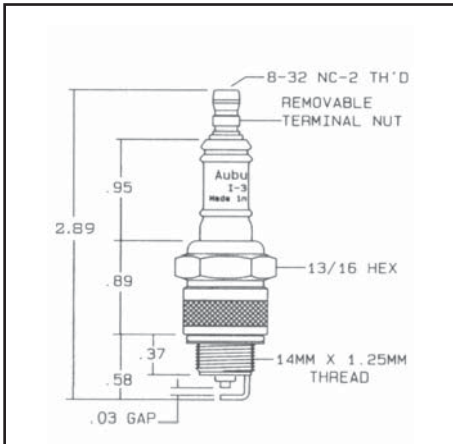

I-141

No.	Ref. No.
E5-I-141	I-141

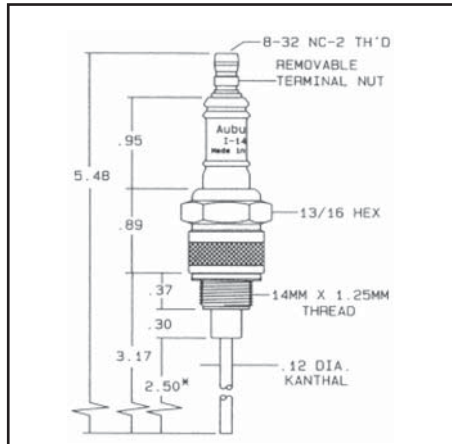

I-143

No.	Ref. No.
E5-I-143	I-143

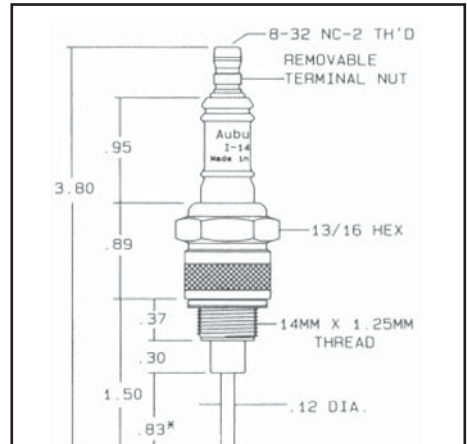

I-144

No.	Ref. No.
E5-I-144	I-144

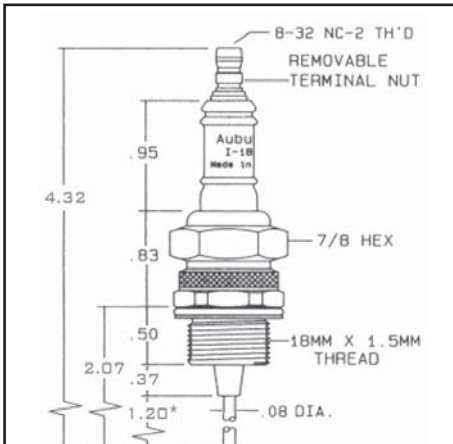

I-180

No.	Ref. No.
E5-I-180	I-180

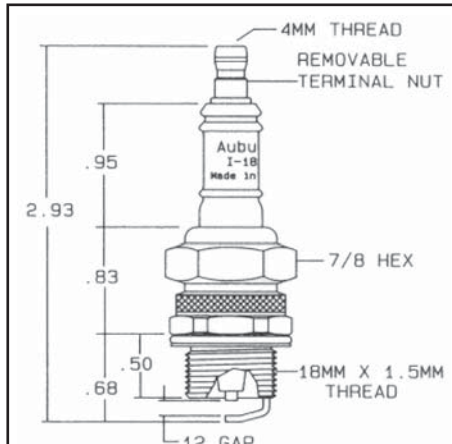

I-181

No.	Ref. No.
E5-I-181	I-181

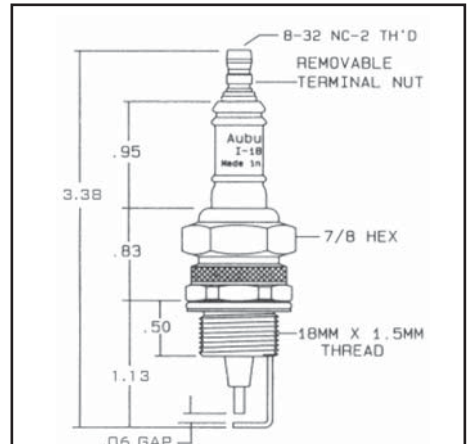

I-182

No.	Ref. No.
E5-I-182	I-182

* Dimensions marked with an asterisk are standard lengths - Other lengths available upon request

AUBURN ELECTRODES

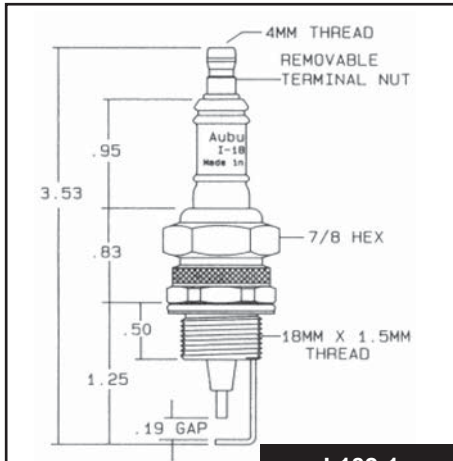

I-182-1

No.	Ref. No.
E5-I-182-1	I-182-1

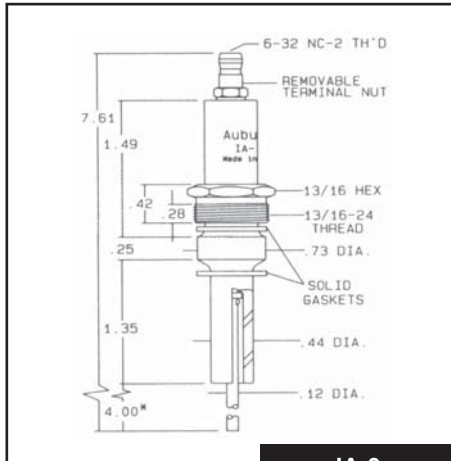

IA-9

No.	Ref. No.
E5-IA-9	IA-9

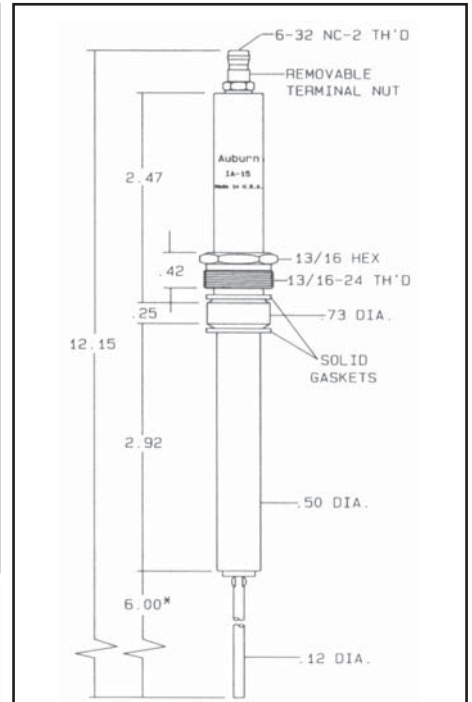

IA-15

No.	Ref. No.
E5-IA-15	IA-15

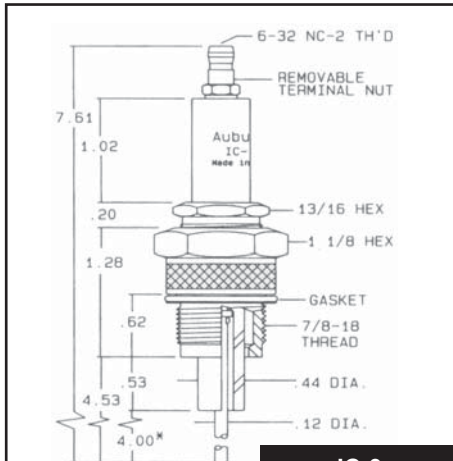

IC-9

No.	Ref. No.
E5-IC-9	IC-9

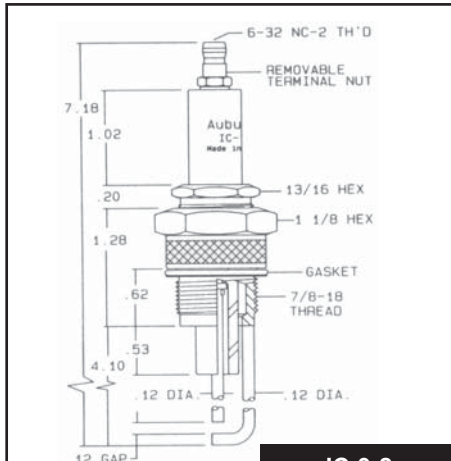

IC-9-2

No.	Ref. No.
E5-IC9-2	IC9-2

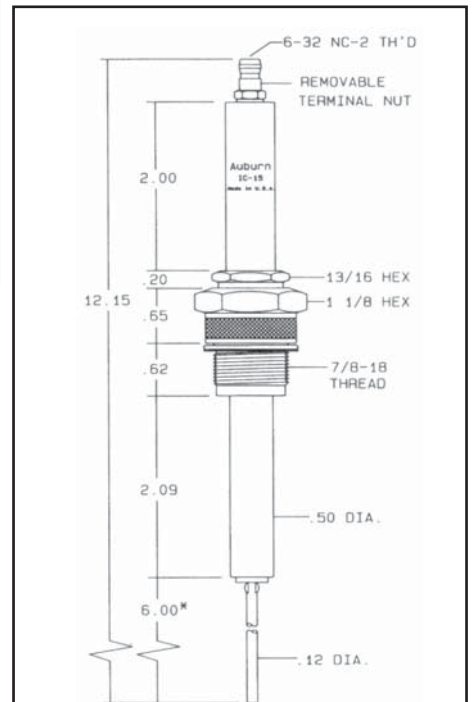

IC-15

No.	Ref. No.
E5-IC-15	IC-15

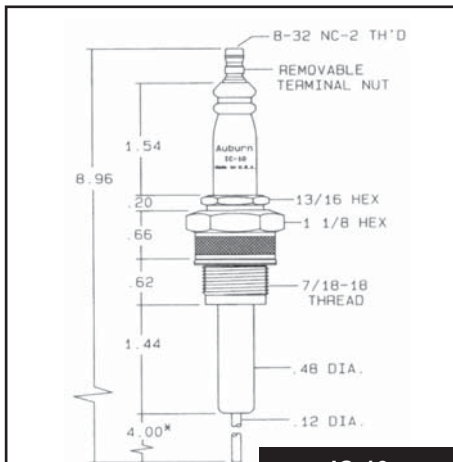

IC-10

No.	Ref. No.
E5-IC-10	IC-10

As a major distributor of Auburn Ignition Products, Westwood can special order any Auburn item not shown in this catalog and get it to you fast!

* Dimensions marked with an asterisk are standard lengths - Other lengths available upon request

AUBURN ELECTRODES

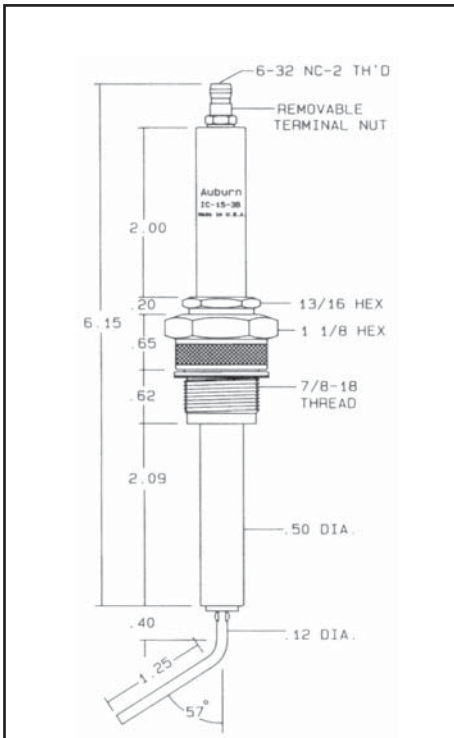

CHROME "D"
Center Wire

IC-15-3B

No.	Ref. No.
E5-IC-15-3B	IC-15-3B

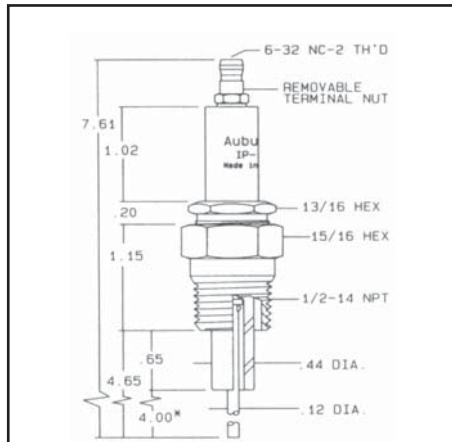

IP-9

No.	Ref. No.
E5-IP-9	IP-9

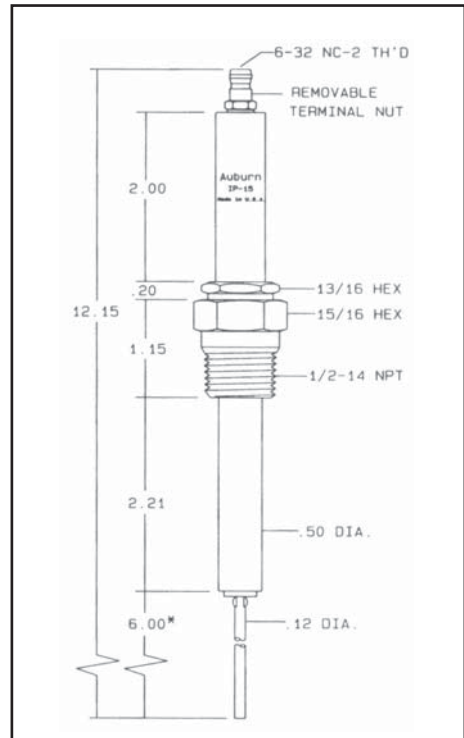

IP-15

No.	Ref. No.
E5-IP-15	IP-15

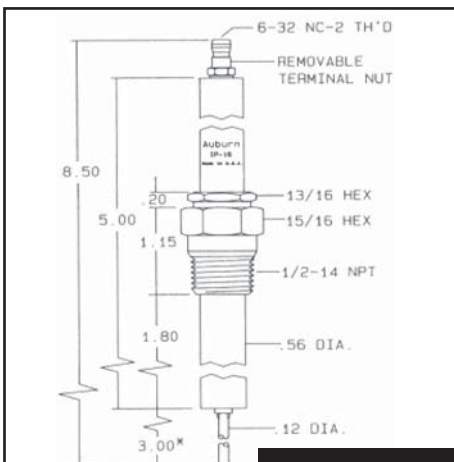

IP-16

No.	Ref. No.
E5-IP-16	IP-16

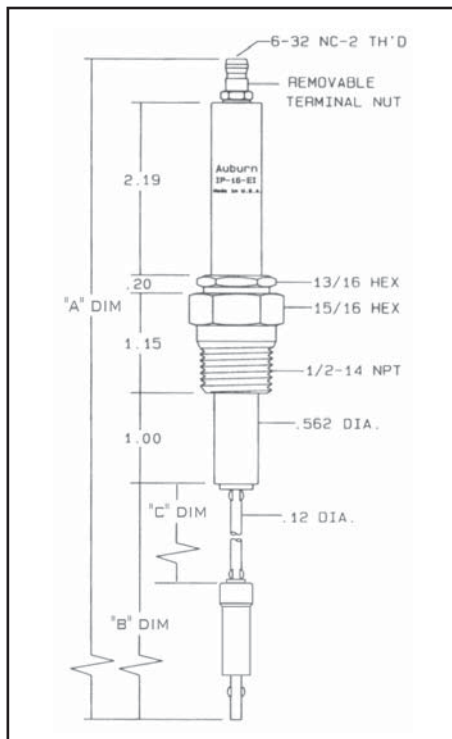

IP-16-EI Series

No.	Ref. No.	"A"	"B"	"C"
E5-IP-16-EI	IP-16-EI	18.75	13.25	11.25
E5-IP-16-EI-1	IP-16-EI-1	11.75	6.25	4.25

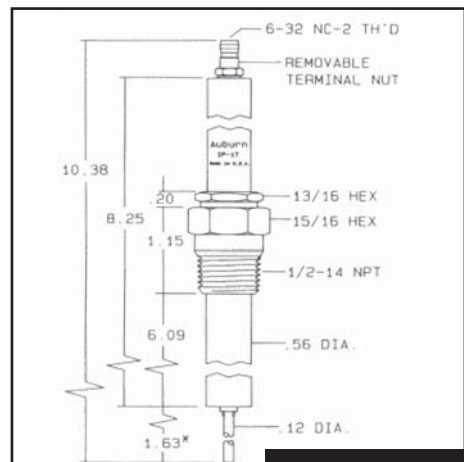

IP-17

No.	Ref. No.
E5-IP-17	IP-17

* Dimensions marked with an asterisk are standard lengths - Other lengths available upon request

AUBURN ELECTRODES & FLAME RODS

IP-19

W/P No.	Ref. No.
E5-IP-19	IP-19

OJ-21-1

W/P No.	Ref. No.
E5-OJ-21-1	OJ-21-1

OJ-21-4

W/P No.	Ref. No.
E5-OJ-21-4	OJ-21-4

OJ-21-5

W/P No.	Ref. No.
E5-OJ-21-5	OJ-21-5

FLAME ROD FRS-2 Series
Center electrode tip operating temp 2,350° F

W/P No.	Ref. No.	"A" DIM.
E5-FRS-2-6	FRS-2-6	6"
E5-FRS-2-12	FRS-2-12	12"
E5-FRS-2-18	FRS-2-18	18"
E5-FRS-2-24	FRS-2-24	24"

FLAME ROD FRS-4 Series
Center electrode tip operating temp 2,350° F

W/P No.	Ref. No.	"A" DIM.
E5-FRS-4-4	FRS-4-4	4"
E5-FRS-4-6	FRS-4-6	6"
E5-FRS-4-12	FRS-4-12	12"
E5-FRS-4-18	FRS-4-18	18"
E5-FRS-4-24	FRS-4-24	24"

FLAME ROD FRS-3

W/P No.	Ref. No.
E5-FRS-3	FRS-3

* Dimensions marked with an asterisk are standard lengths - Other lengths available upon request

Please order by No.

AUBURN LIQUID LEVEL ELECTRODES

WCC Series:

Metal parts are 303 or 304 non-magnetic stainless steel. Incorporates an internal conductive glass seal (not recommended for use above 450 volts). Non-steam applications up to 2,500 PSI at 120° F or 0 PSI at 700° F. Steam applications up to 250 PSI at 406° F

WCC-KH Series:

Metal parts are 303 or 304 non-magnetic stainless steel. Incorporates a special insulator tip seal and Kovar center wire-glass seal. Non-steam applications up to 2,500 PSI at 120° F or 0 PSI at 450° F. Steam applications up to 450 PSI at 459° F

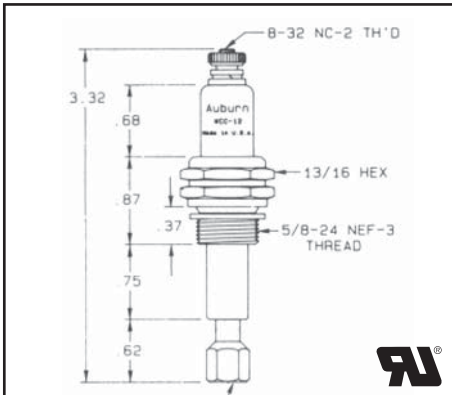

WCC-12

No.	Ref. No.
E5-WCC-12	WCC-12

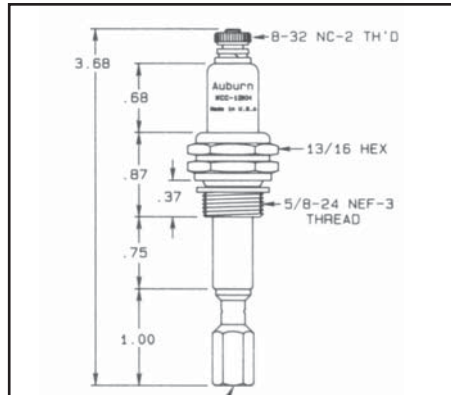

WCC-12KH

No.	Ref. No.
E5-WCC-12KH	WCC-12KH

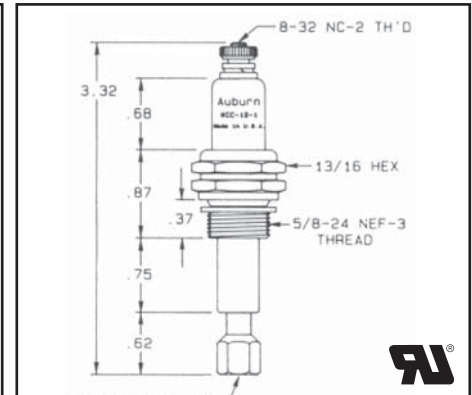

WCC-12-1

No.	Ref. No.
E5-WCC-12-1	WCC-12-1

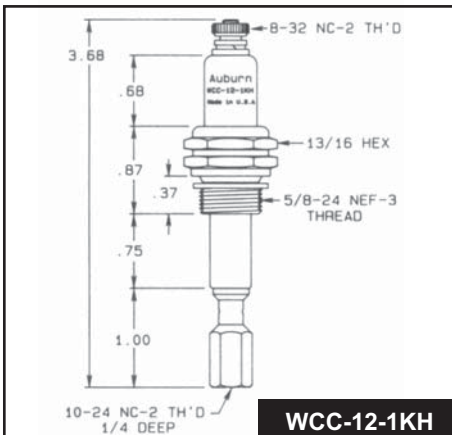

WCC-12-1KH

No.	Ref. No.
E5-WCC-12-1KH	WCC-12-1KH

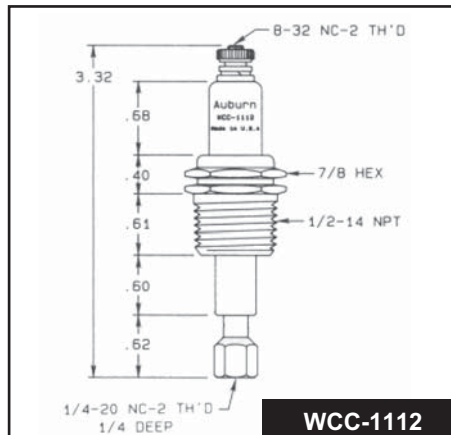

WCC-1112

No.	Ref. No.
E5-WCC-1112	WCC-1112

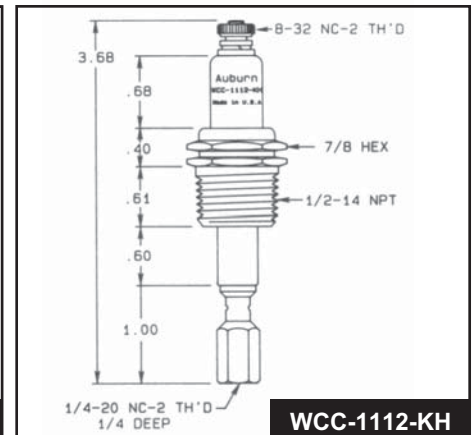

WCC-1112-KH

No.	Ref. No.
E5-WCC-1112-KH	WCC-1112-KH

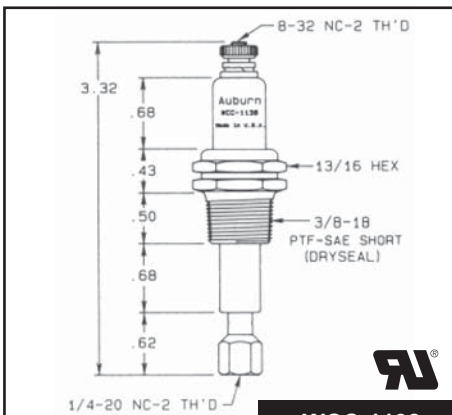

WCC-1138

No.	Ref. No.
E5-WCC-1138	WCC-1138

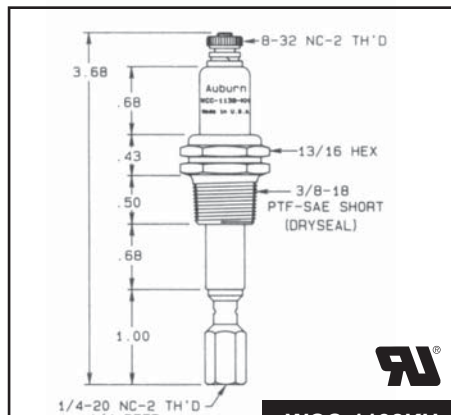

WCC-1138KH

No.	Ref. No.
E5-WCC-1138KH	WCC-1138KH

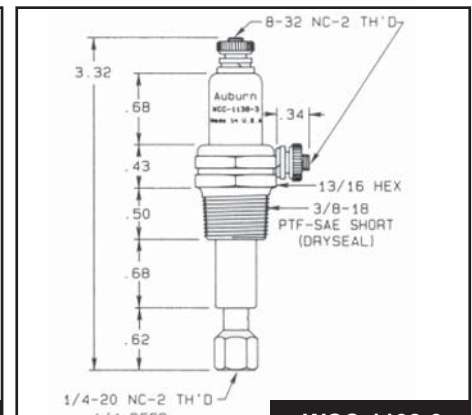

WCC-1138-3

No.	Ref. No.
E5-WCC-1138-3	WCC-1138-3

AUBURN LIQUID LEVEL ELECTRODES

WCT Series:

Metal parts are 303 or 304 non-magnetic stainless steel, center electrodes are one piece.

Non-steam applications up to 1,000 PSI at 120° F or 0 PSI at 400° F

Steam applications up to 100 PSI at 337° F

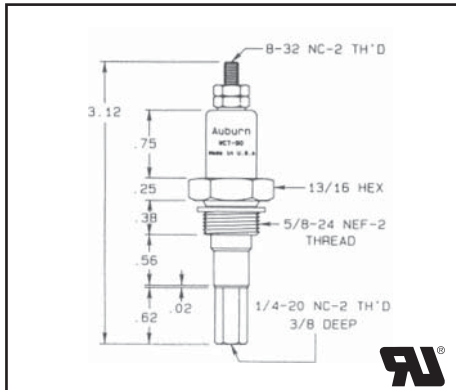

WCT-90

No.	Ref. No.
E5-WCT-90	WCT-90

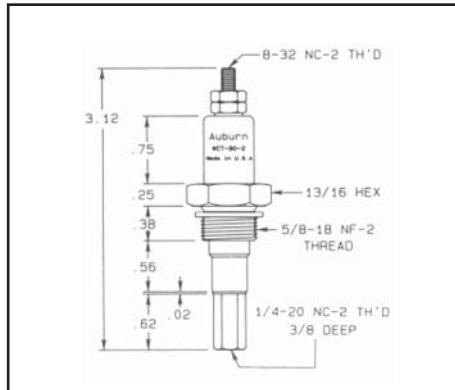

WCT-90-2

No.	Ref. No.
E5-WCT-90-2	WCT-90-2

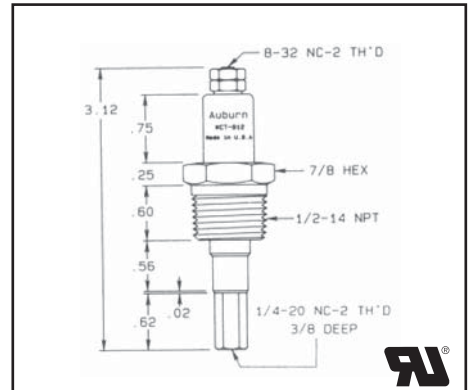

WCT-912

No.	Ref. No.
E5-WCT-912	WCT-912

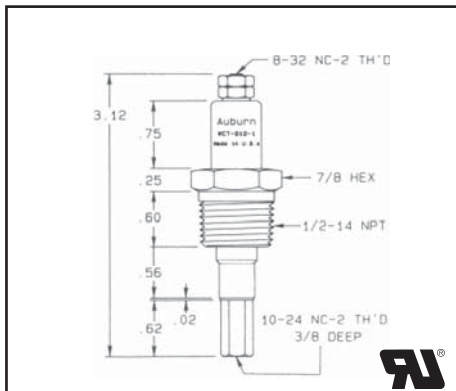

WCT-912-1

No.	Ref. No.
E5-WCT-912-1	WCT-912-1

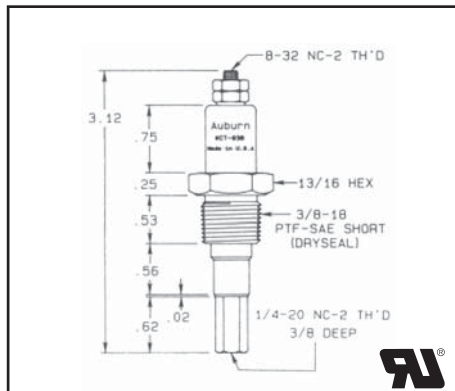

WCT-938

No.	Ref. No.
E5-WCT-938	WCT-938

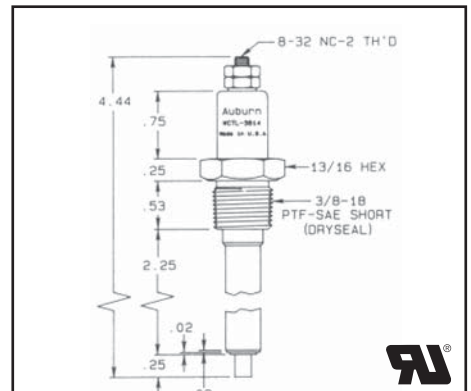

WCTL-3814

No.	Ref. No.
E5-WCTL-3814	WCTL-3814

As a major distributor of Auburn Liquid Level Electrodes, Westwood can special order any Auburn item not shown in this catalog and get it to you fast!





LIQUID LEVEL PROBES for FULTON BOILERS on page H7

Please order by No.

LIQUID LEVEL ELECTRODES PROBES

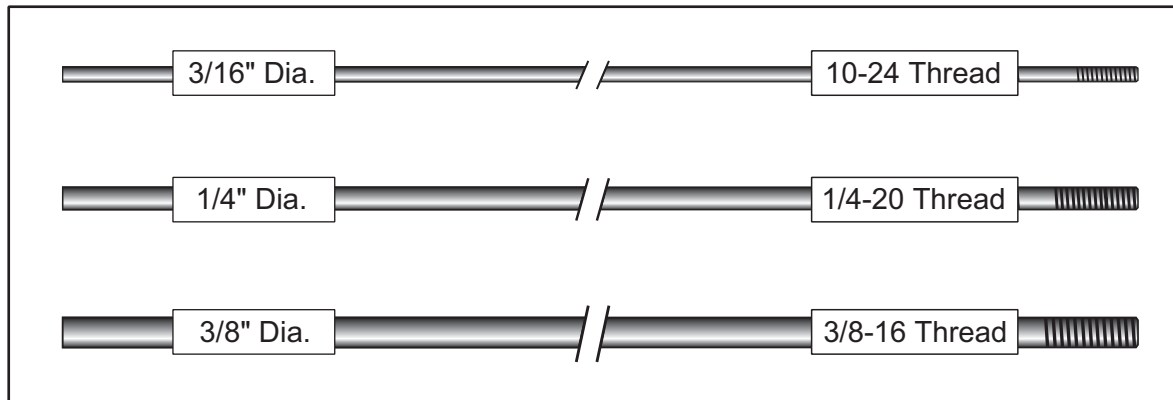
Westwood

SOLID STAINLESS STEEL PROBES**FOR USE ON LIQUID LEVEL ELECTRODE ASSEMBLIES****STANDARD SIZES***

 No.	Ref. No.	Thread	Length	Diameter
E5-1024-12	1024-12	10-24	12"	3/16"
E5-1024-18	1024-18	10-24	18"	3/16"
E5-1024-24	1024-24	10-24	24"	3/16"
E5-1420-6	1420-6	1/4-20	6"	1/4"
E5-1420-12	1420-12	1/4-20	12"	1/4"
E5-1420-18	1420-18	1/4-20	18"	1/4"
E5-1420-24	1420-24	1/4-20	24"	1/4"
E5-1420-36	1420-36	1/4-20	36"	1/4"
E5-3816-12	3816-12	3/8-16	12"	3/8"
E5-3816-18	3816-18	3/8-16	18"	3/8"
E5-3816-24	3816-24	3/8-16	24"	3/8"

*Made to order non-standard lengths available by special order.



Take a look ...

LIQUID LEVEL PROBES for
FULTON BOILERS on page H7



NOTE: Champion ignition assembly part numbers are now "E5-" followed by the former number.

Example:

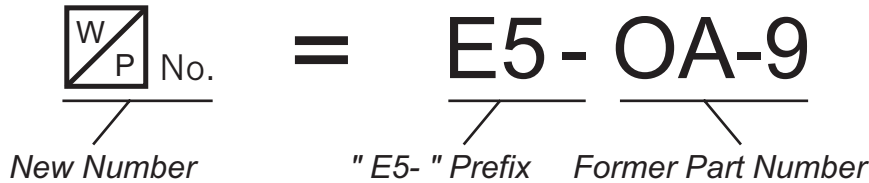

$\frac{W}{P}$ No.	Ref. No.
E5-OA-9	OA-9

$\frac{W}{P}$ No.	Ref. No.
E5-OC-15-6	OC-15-6

$\frac{W}{P}$ No.	Ref. No.
E5-OP-9-12	OP-9-12

$\frac{W}{P}$ No.	Ref. No.
E5-OP-15-6	OP-15-6

CHAMPION IGNITION ASSEMBLIES

Westwood

CHAMPION

IGNITION ASSEMBLIES



A-25

<input checked="" type="checkbox"/> No.	Ref. No.
E5-A-25	A-25



CJ-8

<input checked="" type="checkbox"/> No.	Ref. No.
E5-CJ-8	CJ-8



D-9

<input checked="" type="checkbox"/> No.	Ref. No.
E5-D-9	D-9



D-89D

<input checked="" type="checkbox"/> No.	Ref. No.
E5-D-89D	D-89D



H14Y

<input checked="" type="checkbox"/> No.	Ref. No.
E5-H14Y	H14Y



J-99

<input checked="" type="checkbox"/> No.	Ref. No.
E5-J-99	J-99



K97F

<input checked="" type="checkbox"/> No.	Ref. No.
E5-K97F	K97F



UY-6

<input checked="" type="checkbox"/> No.	Ref. No.
E5-UY-6	UY-6



W18

<input checked="" type="checkbox"/> No.	Ref. No.
E5-W18	W18



W-95D

<input checked="" type="checkbox"/> No.	Ref. No.
E5-W-95D	W-95D



Z-6

<input checked="" type="checkbox"/> No.	Ref. No.
E5-Z-6	Z-6



TERMINALS



SPECIAL NOTE: NEW Rajah™ TERMINAL PART NUMBERS

Rajah™ terminals and related items part numbers are now "E9-" followed by the former part number.

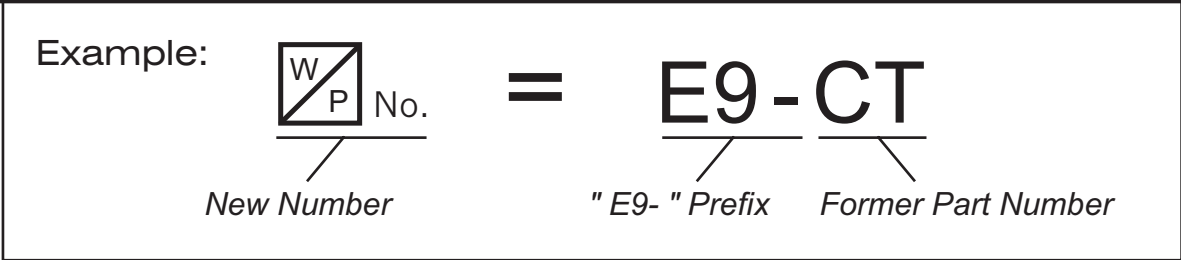

Note: Terminal part number endings of 6-32, 8-32, 10-24, and 10-32 refer to terminal thread size

 No. E9-CT	 No. E9-SS	 No. E9-R-2	 No. E9-SF	 No. E9-TT
 No. E9-CT-TS 8-32 E9-CT-TS 10-32	 No. E9-SS-TS 10-32	 No. E9-SR	 No. E9-HS 6-32 E9-HS 10-32	 No. E9-CT-BS 6-32 E9-CT-BS 8-32 E9-CT-BS 10-32
 No. E9-SS-BS 6-32 E9-SS-BS 8-32 E9-SS-BS 10-32	 No. E9-HT 6-32 E9-HT 8-32 E9-HT 10-32	 No. E9-SX-1 6-32 E9-SX-1 10-32	 No. E9-CT-SS	 No. E9-ACT
 No. E9-ASS	 No. E9-CHT	 No. E9-BS 6-32 E9-BS 8-32 E9-BS 10-24 E9-BS 10-32	 No. E9-458-9 10-32	 No. E9-RAC
 No. E9-RASS	 No. E9-EBS 6-32 E9-EBS 10-32	 No. E9-457-6 6-32	 No. E9-SS-SOS	 No. E9-R-SOS

Please order by No.

RAJAH TERMINALS



TERMINALS



Note: Terminal part number endings of 6-32, 8-32, 10-24, and 10-32 refer to terminal thread size

































 W/P No. E9-T-SOS	 W/P No. E9-AS-SOS	 W/P No. E9-BS-SOS	 W/P No. E9-SSN	 W/P No. E9-RSN
 W/P No. E9-TSN	 W/P No. E9-ASN	 W/P No. E9-BSN	 W/P No. E9-ACT-BS 6-32 E9-ACT-BS 10-32	 W/P No. E9-DS-1
 W/P No. E9-FF-1	 W/P No. E9-CC-1	 W/P No. E9-SS-LBS 6-32	 W/P No. E9-SS-LTS 6-32	 W/P No. E9-XC
 W/P No. E9-SA-1 6-32	 W/P No. E9-ITN 8-32 E9-ITN 10-32	 W/P No. E9-ITN-S 6-32 E9-ITN-S 8-32	 W/P No. E9-TC-10	 W/P No. E9-TS-10
 W/P No. E9-R-1	 W/P No. E9-RS-3 10-32	 W/P No. E9-RX-4 6-32 E9-RX-4 8-32 E9-RX-4 10-32	 W/P No. E9-RX-5 10-32	 W/P No. E9-RP-6
 W/P No. E9-RC-5	 W/P No. E9-RE-7	 W/P No. E9-AEBF	 W/P No. E9-EBF	 W/P No. E9-B-10 10-32 5/16" Long
 W/P No. E9-B-11 10-32 1 1/16" Long	 W/P No. E9-BC-11	 W/P No. E9-BS-12		







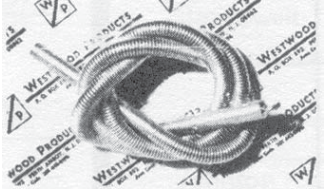













TERMINALS



Note: Terminal part number endings of 6-32, 8-32, 10-24, and 10-32 refer to terminal thread size

 Rickett  No. E9-S-15 10-32	  No. E9-AL-10	  No. E9-AS-10	  No. E9-ASC	  No. E9-S-10
  No. E9-CS	  No. E9-YL-10	  No. E9-YS-10	  No. E9-YSC	1-1/8" Long   No. E9-SCS-2 6-32
1-1/4" Long   No. E9-SCS-1 10-32	  No. E9-KBN 6-32 E9-KBN 10-24	  No. E9-ET	  No. E9-DT	  No. E9-#10 LUG
 Cleaver Brooks Spring Connects plate assembly to ignitors 20" Long  No. E9-CBS				

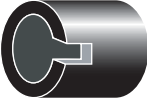
SPECIALTY TERMINAL & ELECTRODE HARDWARE

  No. E9-686 BAR	  No. E9-BB	  No. E9-PB	  No. E9-AB	  No. E9-DB
Cleaver Brooks ring - Zinc plated steel   No. E9-CBR	Copper gasket - dished   No. E9-467 GASKET	Copper gasket - flat   No. E9-I-18 GASKET	Ray - black bakelite   No. E9-500 SHIELD	

BUSS BARS

 No.	Ref. No.	12" Length*
E9-TYPE ET	Type ET	Round brass with eyelet and 6-32 thread
E9-TYPE F	Type F	Flat brass with 1/8" hole
E9-TYPE ST	Type ST	Round brass with 6-32 thread

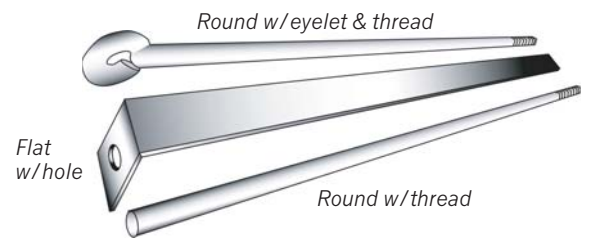





* Other lengths available up to 24"

Please order by  No.

RAJAH TERMINAL KITS

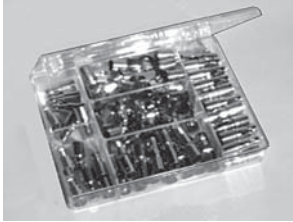

IGNITION TERMINAL KITS

 No.	Ref. No.	Description
	34	Rajah™ "Mini" Ignition Terminal Kit:
		20 - CT Cage Terminals 12 - SS Spring Snap Terminals 20 - R2 Ring Terminals 10 - RAC Right Angle Cage Terminals 12 - SF Stud Ferrule Terminals
	54	Rajah™ Transformer Terminal Kit:
		6 - AS-10 Short Adapter Spring 6 - AL-10 Long Adapter Spring 2 - STS-10 Thumb Nut on Cage 2 - 458-9 Spring Plunger (10-32) 4 - B-10 Button Contact (short) 2 - B-11 Button Contact (long) 6 - CC-1 Cage on Cage 6 - RC-5 Ram's Horn on Cage 4 - RX4 Ram's Horn on Hex 2 - R1 Ram's Horn Clip 6 - HS Hollow Stud (10-32) 6 - SX Hex Stud (10-32)
	2097	Rajah™ "Pro" Ignition Terminal Kit:
		24 - CT Cage Terminals 24 - SS Spring Snap Terminals 24 - R2 Ring Terminals 24 - SF Stud Ferrule Terminals 24 - RAC Right Angle Cage Terminals 100 - DT Distributor Terminals 24 - FF-1 Ferrule on Ferrule 1 - T200-10 (former #695) Terminal Crimping Tool
	3500	Rajah™ "Deluxe" Ignition Terminal Kit:
		12 - CT Cage Terminals 12 - SS Spring Snap Terminals 12 - R2 Ring Terminals 12 - ACT Angle Cage Terminals 12 - SF Stud Ferrule Terminals 12 - BS Base Stud (6-32) 12 - BS Base Stud (10-32) 12 - HS Hollow Stud (6-32) 12 - HS Hollow Stud (10-32) 12 - CC-1 Cage on Cage 12 - CT-TS Cage on Stud (10-32) 12 - RC-5 Ram's Horn on Cage 12 - R-1 Ram's Horn Clip 12 - #299 Special GE Slotted Stud 12 - SX Hex Stud (10-32) 1 - 1/4" Nut Driver 1 - 5/16" Nut Driver 1 - T200-10 (former #695) Terminal Crimping Tool
	CK-1	Rajah™ Carlin Transformer Contact Kit:
		For in the field conversion on Carlin Burner models 98, 99, 100, 101, 102 Webster transformer model 313-28AB85 2 - Contact clips 2 - Flat washers (#10) 2 - Shakeproof washers (#10) 2 - 10-32 nuts

Westwood CLIPS, RUBBER & CERAMIC BOOTS

ELECTRICAL CLIPS & RUBBER BOOTS

 <p><input checked="" type="checkbox"/> No. E9-LV CLIP</p>	<p><i>Vinyl</i></p>  <p><input checked="" type="checkbox"/> No. E9-LV BOOT</p>	 <p><input checked="" type="checkbox"/> No. E9-20 AMP CLIP</p>	<p><i>Vinyl</i></p>  <p><input checked="" type="checkbox"/> No. E9-20 AMP BOOT</p>
<p><i>Distributor nipple</i></p>  <p><input checked="" type="checkbox"/> No. E9-DN</p>	<p><i>Silicone Rubber</i></p>  <p><input checked="" type="checkbox"/> No. E9-250 BOOT</p>	<p><i>Silicone Rubber</i></p>  <p><input checked="" type="checkbox"/> No. E9-251 BOOT</p>	



Take a look ...

JUMPERS & CORD CLIP SETS on page T12

HIGH TEMPERATURE CERAMIC SPARK PLUG BOOTS with Stainless Steel Terminals

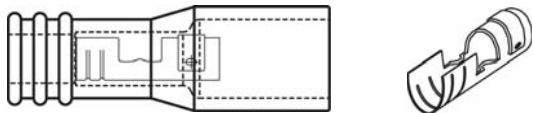
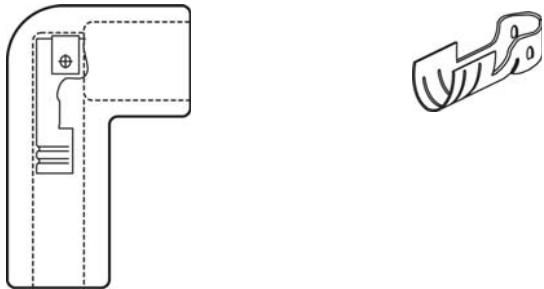
<input checked="" type="checkbox"/> No.	Ref. No.	Description
E9-ECF	ECF	<p>EXTENDED CERAMIC BOOT - with stainless steel terminal for 7mm ignition wire</p> 
E9-AECF	AECF	<p>ANGLE EXTENDED CERAMIC BOOT - with stainless steel terminal for 7mm ignition wire</p> 

IGNITION CABLE

Westwood IGNITION CABLE

Cable Type	UL	W/P No.			
		25' Roll	100' Roll	500' Roll	1,000' Roll
GTO-15	Yes	E60-25	E60-100	E60-500	E60-1000
HV-15	-	E61-25	E61-100	E61-500	E61-1000
White Silicone	-	E62-25	E62-100	-	-
Red Silicone	Yes	E63-25	E63-100	E63-500	E63-1000

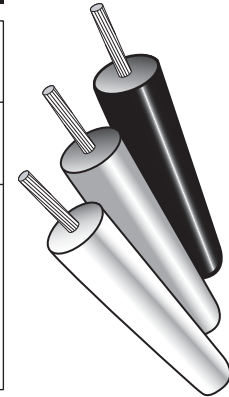

GTO-15	Large .275" outside diameter fits Rajah terminals perfectly. Withstands more than 15,000 VAC with low current leakage. Resists arc-over, tracking, and burning. Tested to withstand conditions of heat, oil, and moisture. No. 14 gauge, 19 x 26 stranded tinned copper wire. All vinyl insulation affords low temperature flexibility. Flame retardant, will not support combustion. Tough and abrasion resistant, yet easy stripping. Temperature range: -40° F to 140° F (-20° C to 60° C)
HV-15	Large .275" outside diameter fits Rajah terminals perfectly. Withstands more than 15,000 VAC with low current leakage. Resists arc-over, tracking, and burning. Tested to withstand conditions of heat, oil, and moisture. No. 16 gauge, 19 x 29 stranded bare copper wire. All vinyl insulation affords low temperature flexibility. Flame retardant, will not support combustion. Tough and abrasion resistant, yet easy stripping. Temperature range: -40° F to 194° F (-20° C to 90° C)
White Silicone	Large .275" outside diameter fits Rajah terminals perfectly. Withstands more than 10,000 VAC and 25,000 VDC with low current leakage. No. 16 gauge, 19 x 26 stranded tinned copper wire. Natural Silicone insulation, high dielectric strength. Temperature range: -65° F to 400° F (-54° C to 204° C)
Red Silicone	Large .275" outside diameter fits Rajah terminals perfectly. Withstands more than 10,000 VAC and 25,000 VDC with low current leakage. No. 16 gauge, 19 x 26 stranded nickel plated copper wire. Natural Silicone insulation, high dielectric strength. Temperature range: -65° F to 482° F (-54° C to 250° C)

CABLE ASSEMBLIES and FIBERGLAS BRAID

W/P No.	Ref. No.	Description
E64	3250	Red Silicone wire high temperature cable assembly with protective metal braid . Temperature range -65° F to 450° F. Overall length is 32-1/2".
E64-5	RS-3350	Red Silicone wire high temperature cable assembly with red Silicone boots . Temperature range -65° F to 450° F. Withstands 10,000 VAC / 25,000 VDC . Overall length is 33-1/2".
E64-20	3253	Fiberglass braided sleeving. Fits over ignition cable for high temperature protection. Sold by the foot. (Ordering example: For 5' of sleeving order 5 of S64-20. Shipped as one piece)

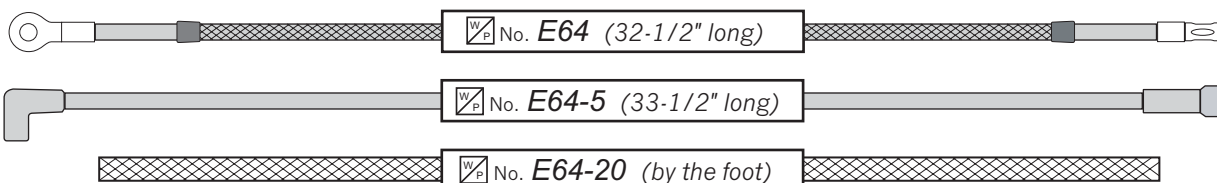

Westwood
CAD CELL FLAME DETECTORS

UNIVERSAL REPLACEMENT FOR HONEYWELL AND WHITE-RODGERS

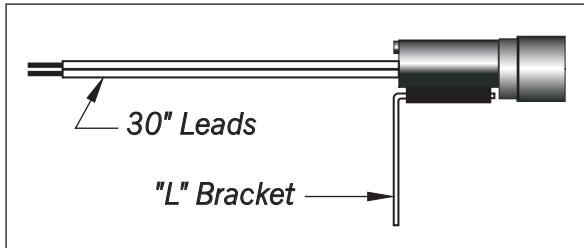
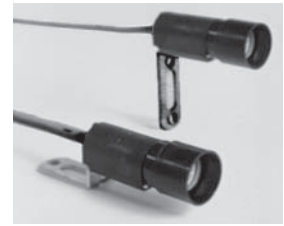

No. **E80**

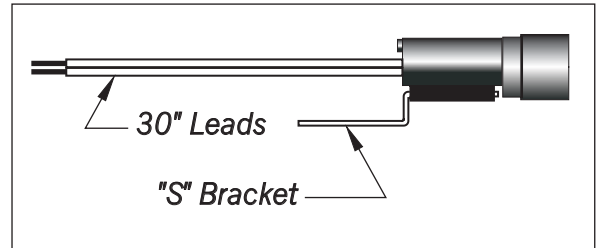

No. **E80-1**

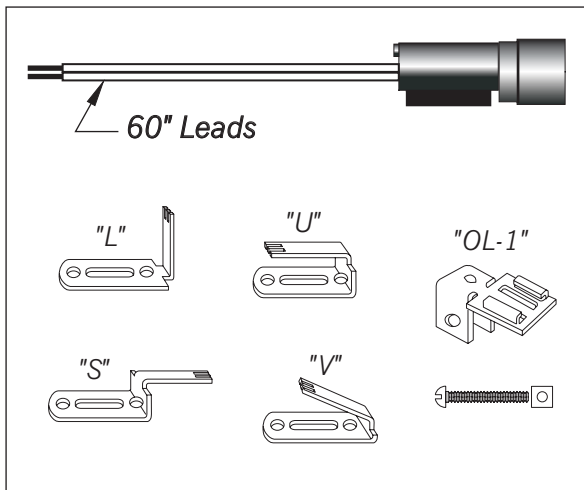

No. **E80-2**

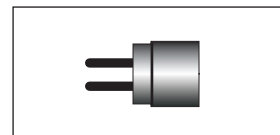

No. **E81**

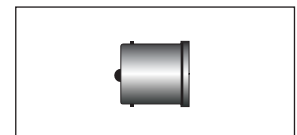

No. **E81-10**

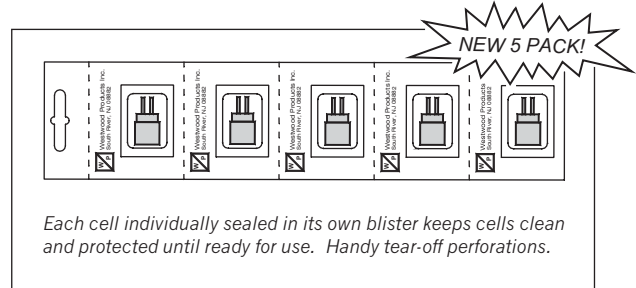

Each cell individually sealed in its own blister keeps cells clean and protected until ready for use. Handy tear-off perforations.

No. **E81-5**

No.	Reference No.	Description
E80	TM-30L	Complete flame detector with cad cell eye*, 30" leads, "L" bracket, poly bag package.
E80-1	TM-30S	Complete flame detector with cad cell eye*, 30" leads, "S" bracket, poly bag package.
E80-2	TMK-60	Complete flame detector kit with cad cell eye*, 60" leads, "L" bracket, "S" bracket, "U" bracket, "V" bracket, "OL-1" special oil line bracket with mounting screw and nut, packaged in a box
E81	Type M	Cad cell eye* packaged in a box
E81-5	-	Cad cell eye* 5 pack (blister card with 5 E81-5 eyes per card), tear-off perforations
E81-10	Type W	Cad cell eye, bayonet mount for White-Rodgers cad cell flame detector, packaged in a box

* Cad cell eye replaces Honeywell 130367 and fits C554A flame detector



T70 Cad cell relay and eye tester on page T10

Please order by No.

VACUUM TUBES & BATTERIES

Westwood

ELECTRONIC VACUUM TUBES

REPLACEMENT TUBES FOR POPULAR HEATING CONTROLS

PREMIUM QUALITY • INDIVIDUALLY BOXED

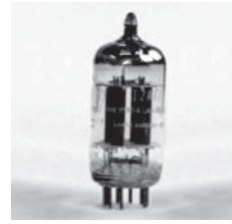







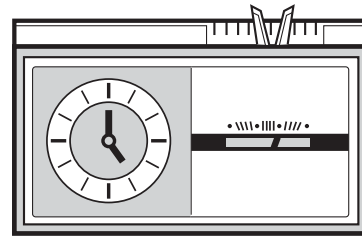

 No.	Ref. No.	Replaces Heatimer	Replaces Honeywell	Replaces Fireye
E100-1	2033	-	115330	-
E100-2	2D21	2D21	-	-
E100-3	5727	5727	-	-
E100-4	6X4	-	107303	-
E100-5	6CG7	-	114624	-
E100-6	12AU7	-	102988	-
E100-7	12AV7	-	105608	-
E100-8	12AX7	-	100668	4-91
E100-9	12BH7	-	-	4-204
E100-10	12H6	-	-	4-98
E100-11	12SL7	-	100196	4-100
E100-12	12SN7	-	101506	4-84

Westwood

RECHARGEABLE THERMOSTAT BATTERIES

LONG LIFE NICKEL CADMIUM



 No.	Ref. No.	Thermostat Manufacturer	Replaces	Used in:	Representative Picture
E115-1*	BH-1	Honeywell	193933, 193933A, 195044	T8082A	
E115-2*	B-1	Honeywell	193933A	T8082A	
E115-3*	B-2	Honeywell	191127B	T8082A	
E115-4	BW-1	White-Rodgers	F145-0664	-	
E115-5	BW-2	White-Rodgers	F145-0655	-	
E115-6	BA-1	American Stabilis	RB1891, NC1891	Superstats, Digistats	

* Provided with 2 crimp connectors for easy battery replacement

THERMOSTAT GUARDS

METAL AND PLASTIC TAMPER PROOF DESIGNS IN PLEASING COLORS

*Designed for use in schools, industrial plants and military installations where **rugged, maximum protection** is the first consideration. The louvered covers cannot be twisted or jammed open. Bobby pins, pencils, letter openers and other such objects cannot be inserted through the cover to adjust the thermostat.*

- ▶ Metal guards are constructed of 18-22 gauge steel with a baked enamel finish
- ▶ Plastic guards are molded from hi-impact plastic and can be used with both horizontally or vertically mounted thermostats
- ▶ All guards come with eight tumbler lock, one key, and mounting hardware
- ▶ Guards with ring bases can be installed without removing the thermostat



No. **E140**

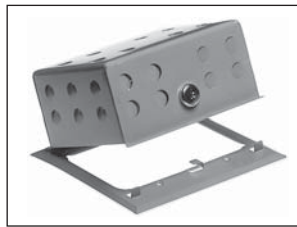

No. **E140-1**

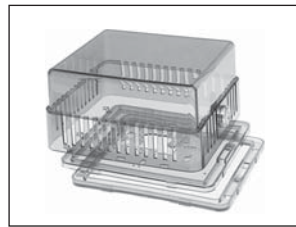

No. **E141**

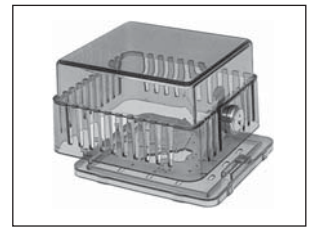

No. **E142**

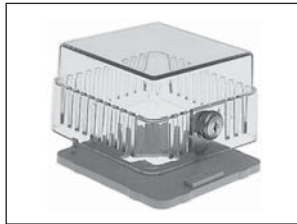

No. **E142-1**

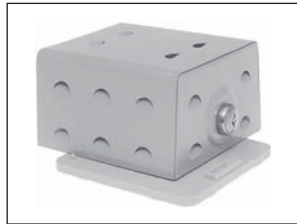

No. **E142-2**

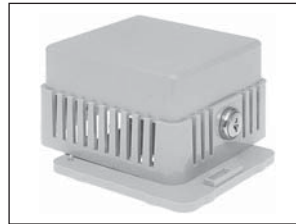

No. **E142-3**

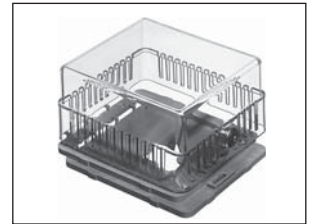

No. **E143**

No.	Ref. No.	Dimensions H" x W" x D"	Mat'l	Color	Base	Comments
E140	WTG-54VL	6-1/4 x 4-3/4 x 3	M	BE	SH	T80, T90, T91, T199, T330, T340, T42, T26, T87, T92, T651, T921, T872, T882
E140-1	WTG-54VLW	6 x 3-13/16 x 3-1/8	M	BE	RH	
E141	WTG-B	5-1/4 x 4-5/8 x 3-1/4	P	BR	SR	
E142	WTG-EB	3-7/8 x 3-1/2 x 2-1/2	P	BR	S	
E142-1	WTG-EK	3-7/8 x 3-1/2 x 2-1/2	P	CL	S	T199, TP970, TP971, TP972, TP973, T26, T87, TS86, T832, T853, TP910
E142-2	WTG-EM	3-7/8 x 3-1/2 x 2-1/2	M	BE	S	
E142-3	WTG-EO	3-7/8 x 3-1/2 x 2-1/2	P	OP	S	
E143	WTG-K	5-1/4 x 4-5/8 x 3-1/4	P	CL	SR	

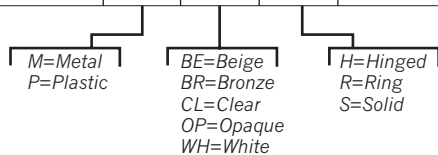

Please order by No.

THERMOSTAT GUARDS

THERMOSTAT GUARDS (CONTINUED)

METAL AND PLASTIC TAMPER PROOF DESIGNS IN PLEASING COLORS

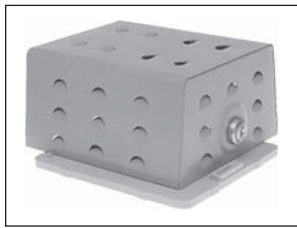

No. **E143-1**

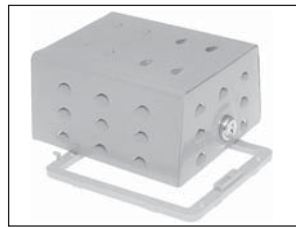

No. **E143-2**

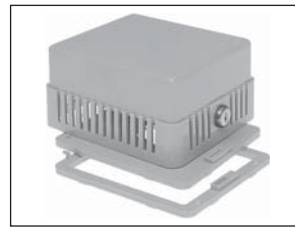

No. **E143-3**

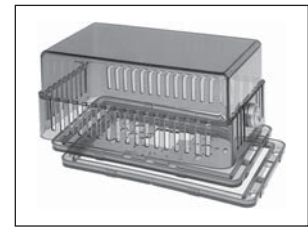

No. **E144**

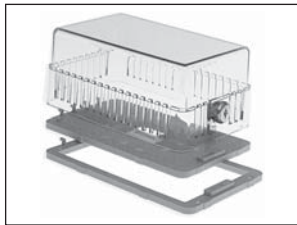

No. **E144-1**

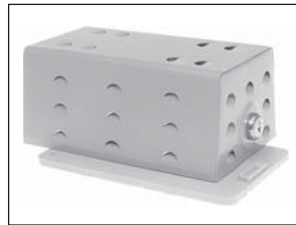

No. **E144-2**

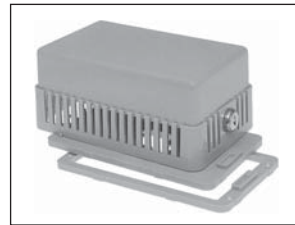

No. **E144-3**

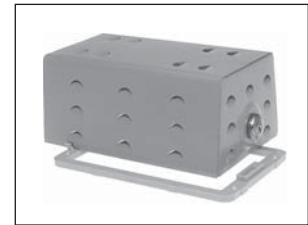

No. **E144-4**

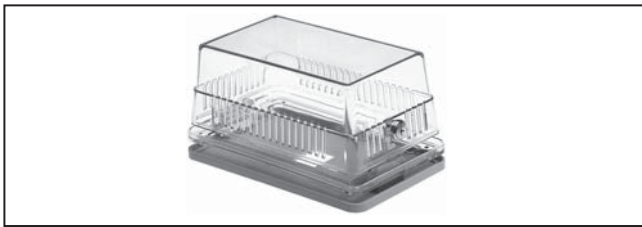

No. **E145 Series**

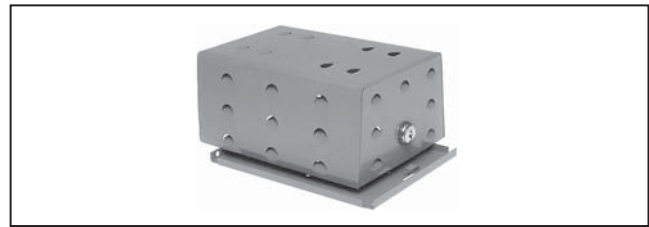

No. **E146**

No.	Ref. No.	Dimensions H" x W" x D"	Mat'l	Color	Base	Comments
E143-1	WTG-KM	5-1/4 x 4-5/8 x 3	M	BE	S	
E143-2	WTG-KWM	5-1/4 x 4-5/8 x 3-1/4	M	BE	R	
E143-3	WTG-O	5-1/4 x 4-5/8 x 3-1/4	P	OP	SR	
E144	WTG-RB	6-3/8 x 3-1/2 x 3-1/4	P	BR	SR	
E144-1	WTG-RK	6-3/8 x 3-1/2 x 3-1/4	P	CL	SR	T80, T90, T91, T99, T199, T330, T340, T42, TA42, T26, TS86, T87, T92, T498, T651, T834, T921, T872, T882
E144-2	WTG-RM	6-3/8 x 3-1/2 x 3	M	BE	S	
E144-3	WTG-RO	6-3/8 x 3-1/2 x 3-1/4	P	OP	SR	
E144-4	WTG-RWM	6-3/8 x 3-1/2 x 3-1/4	M	BE	R	
E145	WTG-UB2	8-1/8 x 4-5/8 x 3-5/8	P	BR	SR	General, White-Rodgers, Barber Colman, Honeywell, Robertshaw, Camstat, Penn
E145-1	WTG-UK2	8-1/8 x 4-5/8 x 3-5/8	P	CL	SR	
E146	WTG-UM	7-1/4 x 5-3/8 x 3-1/2	M	BE	S	

M=Metal
 P=Plastic
 BE=Beige
 BR=Bronze
 CL=Clear
 OP=Opaque
 WH=White
 H=Hinged
 R=Ring
 S=Solid

THERMOSTAT GUARDS (CONTINUED)

METAL AND PLASTIC TAMPER PROOF DESIGNS IN PLEASING COLORS

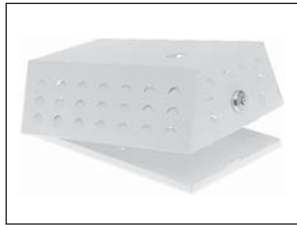

No. **E147 Series**

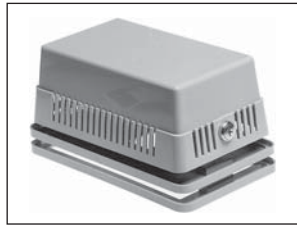

No. **E148**

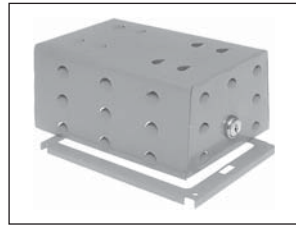

No. **E149**

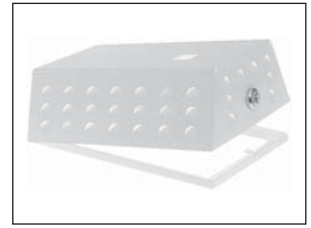

No. **E150 Series**

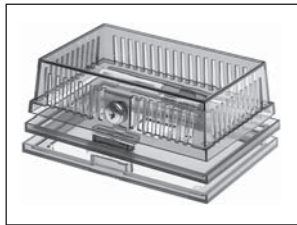

No. **E151**

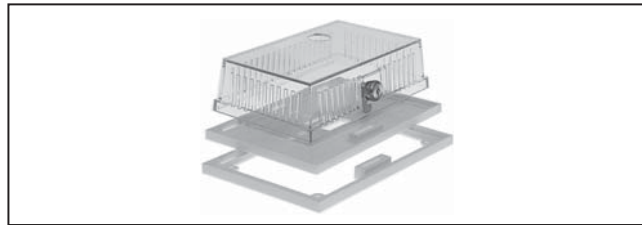

No. **E151-1, -2**

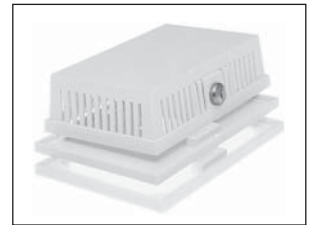

No. **E151-3**

No.	Ref. No.	Dimensions H" x W" x D"	Mat'l	Color	Base	Comments
E147	WTG-UM1	9-3/8 x 6-3/4 x 3	M	WH	SH	Honeywell T7300 series
E147-1	WTG-UM1DH	9-3/8 x 6-3/4 x 3	M	WH	SH	Honeywell T7300 series w/ display opening
E147-2	WTG-UM1DOH	9-3/8 x 6-3/4 x 3	M	WH	SH	Honeywell T7300 series w/ override/ display opening
E147-3	WTG-UM1DOWR	9-3/8 x 6-3/4 x 3	M	WH	SH	White-Rodgers IF90 series w/ override/ display opening
E147-4	WTG-UM1OH	9-3/8 x 6-3/4 x 3	M	WH	SH	Honeywell T7300 series w/ override opening
E147-5	WTG-UM1SDH	9-3/8 x 6-3/4 x 3	M	WH	SH	Honeywell T7400 series w/ display opening
E148	WTG-UO2	8-1/8 x 4-5/8 x 3-5/8	P	OP	SR	
E149	WTG-UWM	6-3/4 x 4-1/4 x 3-9/16	M	BE	R	
E150	WTG-UWM1	9-3/8 x 6-3/4 x 3	M	WH	RH	Honeywell T7300 series
E150-1	WTG-UWM1DH	9-3/8 x 6-3/4 x 3	M	WH	RH	Honeywell T7300 series w/ display opening
E150-2	WTG-UWM1DOH	9-3/8 x 6-3/4 x 3	M	WH	RH	Honeywell T7300 series w/ override/ display opening
E150-3	WTG-UWM1DOWR	9-3/8 x 6-3/4 x 3	M	WH	RH	White-Rodgers IF90 series w/ override/ display opening
E150-4	WTG-UWM1OH	9-3/8 x 6-3/4 x 3	M	WH	RH	Honeywell T7300 series w/ override opening
E150-5	WTG-UWM1SDH	9-3/8 x 6-3/4 x 3	M	WH	RH	Honeywell T7400 series w/ display opening
E151	WTG-DB	4-1/8 x 7-1/16 x 2-1/4	P	BR	SR	
E151-1	WTG-DK	4-1/8 x 7-1/16 x 2-1/4	P	CL	SR	
E151-2	WTG-DK1	4-1/8 x 7-1/16 x 2-1/4	P	CL	SR	w/ override opening
E151-3	WTG-DO	4-1/8 x 7-1/16 x 2-1/4	P	OP	SR	

M=Metal
 P=Plastic
 BE=Beige
 BR=Bronze
 CL=Clear
 OP=Opaque
 WH=White
 H=Hinged
 R=Ring
 S=Solid

Please order by No.

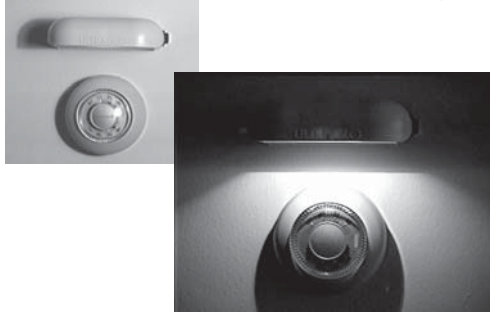
ULTRAGLO & ZONE VALVE MOTOR**ULTRAGLO™ Thermostat Light**
Mounts anywhere!

This easy to mount battery powered light has an ultra bright bulb that draws little current. It can be mounted in any convenient location with the two mounting screws provided. Easily slips out of its mounting bracket for use as a hand light. Use in cars, boats, RVs and campers too!

 No. **E140-40**

REPLACEMENT ZONE VALVE MOTOR

For motor driven OPEN, spring return CLOSE valves
(ie. Erie, Flare, Honeywell, Superior)

INSTALLS WITHOUT REMOVING VALVE FROM PIPING

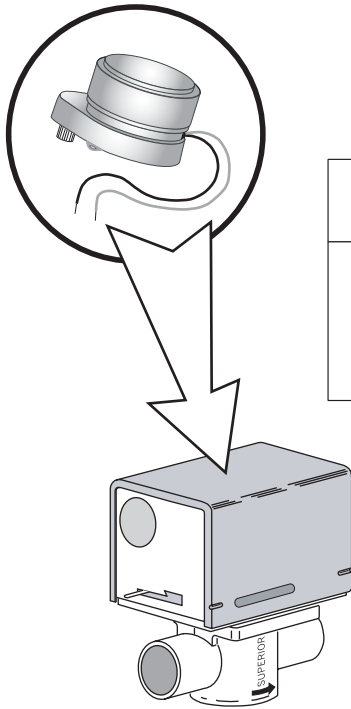

 No.	Description
E180	Individually packaged with installation instructions and wire nuts 24 VAC, 50/60 Hz, .32 A

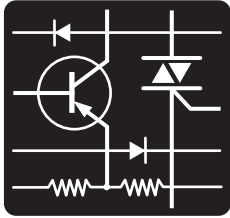

SOLID STATE ELECTRONIC IGNITERS



- ⚡ Higher secondary voltages for smooth sure ignition (secondary midpoint grounded)
- ⚡ Constant duty rating for added reliability

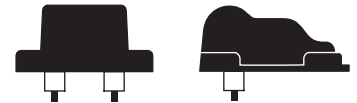
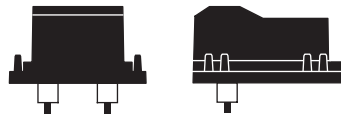

- ⚡ All solid state for trouble free service life
- ⚡ Epoxy sealed against dirt and water
- ⚡ UL recognized - US and Canada



 No.	Description	
E200	Rajah™ Igniter only	Pri. 120VAC Sec. 14kV (p-p)

 No.	Description	
E250	Beckett Igniter only	Pri. 120VAC Sec. 20kV (p-p)

 No.	 No.	For use on:
Complete*	Plate only	
E200-10	E200-11	Beckett AF, AFG
E200-14	E200-15	Beckett S, SR
E200-20	E200-21	Carlin EZ, 99-102CRD
E200-24	E200-25	Carlin 201-301CRD
E200-28	E200-29	Carlin 601-801CRD
E200-34	E200-35	Wayne E
E200-38	E200-39	Wayne M
E200-40	E200-41	Aero

 No.	 No.	For use on:
Complete*	Plate only	
E250-10	E250-11	Beckett AF, AFG
E250-14	E250-15	Beckett S, SR
E250-20	E250-21	Carlin EZ, 99-102CRD
E250-24	E250-25	Carlin 201-301CRD
E250-28	E250-29	Carlin 601-801CRD
E250-34	E250-35	Wayne E
E250-38	E250-39	Wayne M
E250-40	E250-41	Aero

*Includes mounting plate, terminals, and necessary accessories

Please order by  No.

FILTERS

Westwood

PREMIUM FUEL FILTERS

ALUMINUM TOP WITH EPOXY COATING INSIDE!



FEATURING THE LATEST COMPUTER DESIGNED CAST ALUMINUM TOP, CHOICE OF ELEMENT TYPE, AND **EPOXY** COATING INSIDE !

- Advanced design CAST ALUMINUM TOP is the industry's strongest and most corrosion resistant!
- Galvanized canister with EPOXY COATING on the inside - FIRST in the industry!
- Highest UL GPH and pressure rating of any filter in its class
- 360° screwdriver slot makes disassembly for element changing easy



with *Pure Oil*TM

Fiber-Welded White Element

High Efficiency Heating Oil Filter

REPLACES ELEMENT ANNUALLY OR WHEN CLOGGED

UL

360° SCREWDRIVER SLOT FOR EASY DISASSEMBLY

REPLACES ELEMENT ANNUALLY OR WHEN CLOGGED

UL

360° SCREWDRIVER SLOT FOR EASY DISASSEMBLY

W/P No. **F10** W/P No. **F30**

*Ultra-10*TM

10 Micron Pleated Paper Element

High Efficiency Heating Oil Filter

REPLACES ELEMENT ANNUALLY OR WHEN CLOGGED

UL

360° SCREWDRIVER SLOT FOR EASY DISASSEMBLY

REPLACES ELEMENT ANNUALLY OR WHEN CLOGGED

UL

360° SCREWDRIVER SLOT FOR EASY DISASSEMBLY

W/P No. **F12** W/P No. **F32**

CLASSIC *FELT*TM

Wool Felt Stacked Segment Element

High Efficiency Heating Oil Filter

REPLACES ELEMENT ANNUALLY OR WHEN CLOGGED

UL

360° SCREWDRIVER SLOT FOR EASY DISASSEMBLY

REPLACES ELEMENT ANNUALLY OR WHEN CLOGGED

UL

360° SCREWDRIVER SLOT FOR EASY DISASSEMBLY

W/P No. **F15** W/P No. **F35**

COMPLETE FILTERS with EPOXY coated can

W/P No.	Element Type	GPH	PSI	Replaces
F10 F12 F15	Pure-Oil TM Ultra-10 TM CLASSIC FELT TM	17	52	General 1A-25A, Unifilter 77, Sid Harvey (Mitco) 264, 264F
F30 F32 F35	Pure-Oil TM Ultra-10 TM CLASSIC FELT TM	32	52	General 2A-700A, Unifilter 99, Sid Harvey (Mitco) 265, 265F

All filters have 3/8" - NPT pipe connections



UL approved CANISTER UPGRADE KITS on page F9
Individual FILTER GASKETS on page F8

F1

Westwood

CAST IRON TOP FUEL FILTERS

WITH **EPOXY** COATING INSIDE!



- Exact Replacement for popular CAST IRON top filters
- Heavy gage canister with EPOXY COATING on the inside - FIRST in the industry!
- UL GPH and pressure ratings EXCEED comparable OEM filters
- 360° screwdriver slot makes disassembly for element changing easy

CHOICE OF ELEMENT INSIDE



Pure/Oil™
Fiber-Welded White Element



No. **F20**

CLASSIC FELT™
Stacked Segment Element



No. **F25**

CHOICE OF ELEMENT INSIDE



Pure/Oil™
Fiber-Welded White Element

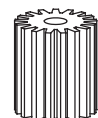

No. **F65**

CLASSIC FELT™
Stacked Segment Element

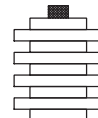

No. **F70**

ELEMENT INSIDE

Pure/Oil™
Fiber-Welded White Element



BIG GUY™
ELEMENT

No. **F80**

ELEMENT INSIDE

CLASSIC YARN™
Honeycomb Wound Element



No. **F84**

COMPLETE CAST IRON TOP FILTERS with EPOXY coated can

<input checked="" type="checkbox"/> No.	Element Type	GPH	PSI	Exact Replacement for:
F20 F25	Pure-Oil™ CLASSIC FELT™	17	52	General 1A-25A
F65 F70	Pure-Oil™ CLASSIC FELT™	32	52	General 2A-700A
F80	Pure-Oil™ BIG GUY™	30	52	FULFLO FB4
F84	CLASSIC YARN™	22	52	

BIG GUY™
ELEMENT
HOLDS TWICE AS MUCH!

All filters have 3/8"- NPT pipe connections



UL approved CANISTER UPGRADE KITS on page F9
Individual FILTER GASKETS on page F8

Please order by No.

FILTERS

Westwood SPIN-ON FUEL FILTERS



THE FIRST EPOXY COATED UL LISTED SPIN-ON!

with



and



1/8"-NPT tapping for vacuum gauge & bleeding
ALL heads tapped for bracket

Cast aluminum top

**25% more capacity
Highest in their class!**

**Highest UL Approved
Pressure & Flow Rate
in their class!**

Seamless one piece canister (drawn steel)

Epoxy coated canister inside

Ultra-10™ 10 Micron filter media

Plated steel end caps (media embedded in thermo setting adhesive)

Precision coil spring



US and Canada

Perforated metal center support tube

Spring pad (no metal to epoxy contact)

HIGH EFFICIENCY FILTRATION - 17 GPH, 40 PSI, 10 micron filter media

W/P No.	Description	Replaces/Fits/Comments
F100	Filter complete, Ultra-10™ filtering media, 17 gph, 3/8" NPT	Gar-Ber 11V-R; Sid Harvey (Mitco) 290, 264-SO; Crown 41439, Nozzle Guard 80000905 w/NG 3000-G
F100-2	F100 filter w/F100-12 bracket	Gar-Ber 11BV-R
F100-4	F100 filter w/F100-14 vac gauge	Gar-Ber 11V-RK
F100-6	F100 filter w/bracket and gauge	Gar-Ber 11BV-RK
F100-8	F100, -1 spin-on top only	Sid Harvey 290-SO, Mitco 290-SOM
F100-10	Spin-on filter element for F100	Gar-Ber R; Sid Harvey (Mitco) 290-6, 264-91; Crown 41436; Nozzle Guard NG 3000-G
F100-12	Mounting bracket for F100-2, -3, -6, -7	
F100-14	Color coded Vac gauge, 1/8" NPT	Gar-Ber Filter Restriction Indicator F.R.I.
F100-16	Universal gauge mount & bleeder fitting	Has 8-32 bleed screw, no gauge removal for bleeding
F100-18	Spin-on filter wrench	For use with all popular spin-on elements

COMMERCIAL DUTY FILTRATION - 37 GPH, 20 psi, 30 micron commercial duty filter media

F100-1	Filter complete, 37 gph, 3/8" NPT	Gar-Ber Commercial; Sid Harvey (Mitco) 292-2, 264-92
F100-3	F100-1 filter w/F100-12 bracket	Gar-Ber 11BV-M; Sid Harvey (Mitco) 292-2B, 264-92B
F100-5	F100-1 filter w/F100-14 vac gauge	Gar-Ber Commercial; Sid Harvey (Mitco) 292-2G, 264-92G
F100-7	F100-1 filter w/bracket and gauge	Gar-Ber 11BV-MK; Sid Harvey (Mitco) 292-2GB, 264-92GB
F100-11	Spin-on filter element for F100-1	Gar-Ber M; Sid Harvey (Mitco) 292-1, 264-93

Westwood

SECONDARY FILTRATION ASSEMBLIES

Fully assembled filter assemblies combining Westwood's premium standard filters with Westwood's ultra fine filters. Connected in series, the PRIMARY filter catches most contamination; the SECONDARY filter traps the small nozzle plugging particles.

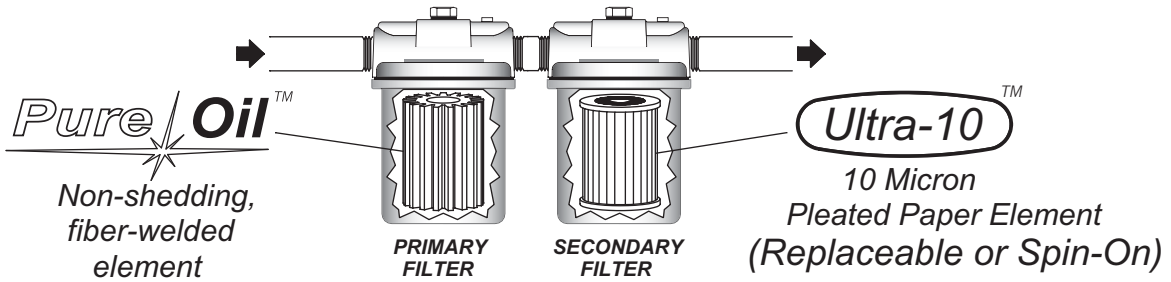

W/P No.	Primary Filter No.	Primary Element	Secondary Filter No.	Secondary Element
F10-12	F10	Pure-Oil™	F12	10 micron pleated paper (replaceable)
F10-100	F10		F100	10 micron spin-on
F30-12	F30		F12	10 micron pleated paper (replaceable)
F30-100	F30		F100	10 micron spin-on
F80-12	F80		F12	10 micron pleated paper (replaceable)
F80-100	F80		F100	10 micron spin-on



All filters have 3/8" NPT pipe connections

Take a look ...

UL approved CANISTER UPGRADE KITS on page F9
Individual FILTER GASKETS on page F8

Please order by No.

FILTER ELEMENTS

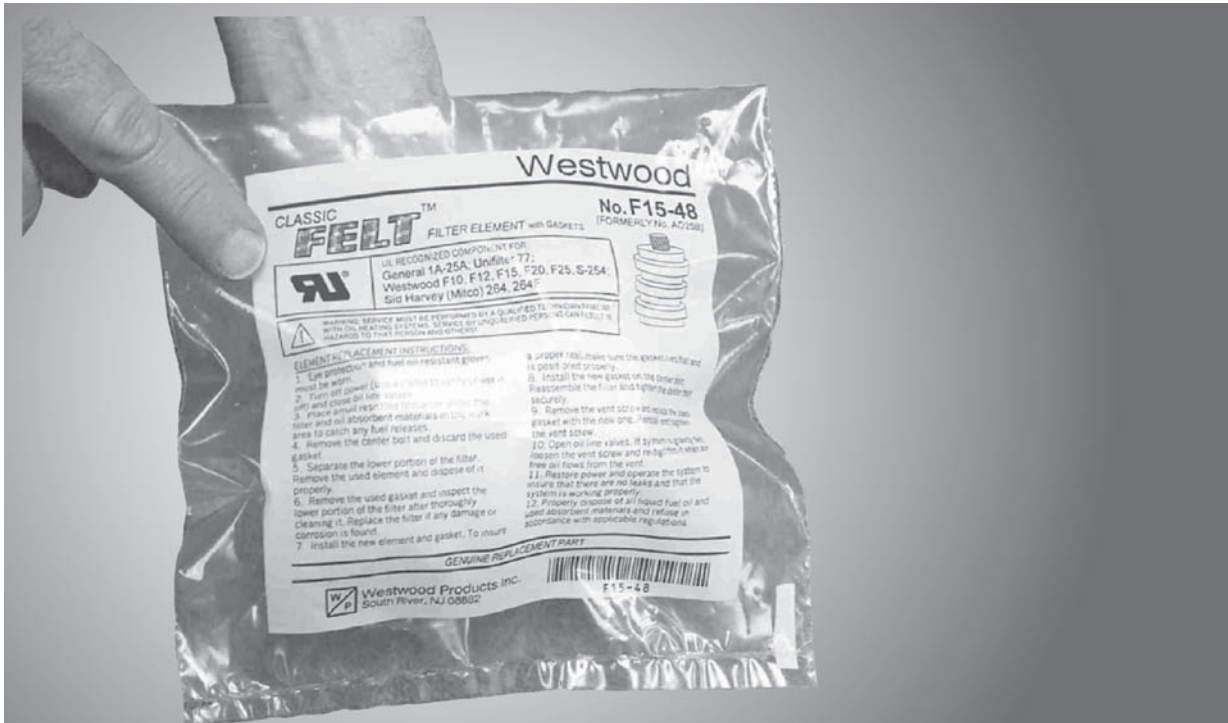

THE ONLY
UL APPROVED
replacement elements



An industry first! Westwood's new line of UL Recognized replacement filter elements are UL approved for use in the General 1A-25A, 2A-700A; Unifilter 77, 99; Sid Harvey (Mitco) 264, 265; Fulflo FB4; and Fromatic C-40, C-50

Be Safe! Always look for the UL Recognized Component symbol



*Pure Oil*TM
FILTER ELEMENTS

- ▶ Latest Computer Designed Shape
- ▶ Largest surface area with most filtering ribs
- ▶ Greater capacity - highest in it's class!
- ▶ Fiber-welded for shed free performance
- ▶ Environmentally friendly processed plant fiber
- ▶ Popular elements UL Recognized Components

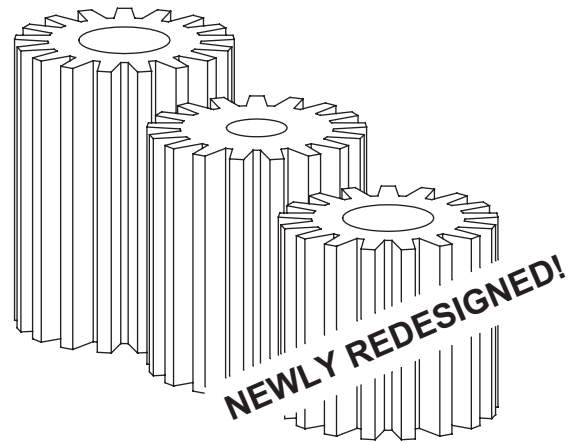

*The Most Advanced Design...
 With the Most Advanced Material!*



 No.	Reference No.	Description	Fits	QTY PKG
F10-48*	PA-25	Pure-Oil TM Individually bagged with gaskets	General 1A-25A; Unifilter 77; Westwood F10, F12, F15, F20, F25; Sid Harvey (Mitco) 264, 264F	48
F30-24*	-	Pure-Oil TM Individually bagged with gaskets	General 2A-700A; Unifilter 99; Westwood F30, F32, F35, F65, F70; Sid Harvey (Mitco) 265, 265F	24
F80-24*	-	Pure-Oil TM BIG GUY TM Ind. bag w/gaskets	Fulflo FB4	24
F80-30*	-	Pure-Oil TM bulk packed less gaskets	Fulflo FB4	30
F80-36*	P4FO-IB	Pure-Oil TM Individually boxed with gaskets	Fulflo FB4	36
F80-48*	-	Pure-Oil TM Individually bagged with gaskets	Fulflo FB4	48
F81-10	-	Pure-Oil TM Individually bagged with gaskets	Fulflo FB6	10
F82-6	-	Pure-Oil TM Individually bagged with gaskets	Fulflo FB8	6
F83-4	-	Pure-Oil TM Individually bagged with gaskets	Fulflo FB10	4
F90-6*	-	Pure-Oil TM Individually bagged with gaskets	Firomatic C-40 (RC-20)	6
F90-12*	-	Pure-Oil TM BIG GUY TM Ind. bag w/gaskets	Firomatic C-40 (RC-20)	12
F90-36*	PF-20	Pure-Oil TM Individually bagged with gaskets	Firomatic C-40 (RC-20)	36
F91-6*	-	Pure-Oil TM Individually bagged with gaskets	Firomatic C-50 (RC-30)	6
F91-12*	-	Pure-Oil TM BIG GUY TM Ind. bag w/gaskets	Firomatic C-50 (RC-30)	12
F91-36*	PF-30	Pure-Oil TM Individually bagged with gaskets	Firomatic C-50 (RC-30)	36
F92-6	-	Pure-Oil TM Individually bagged with gaskets	Purolator PF2002	6
F92-36	PP-20	Pure-Oil TM Individually bagged with gaskets	Purolator PF2002	36
F93-6	-	Pure-Oil TM Individually bagged with gaskets	Fram 1210, 1210A (2-1/4")	6
F93-36	PM-12	Pure-Oil TM Individually bagged with gaskets	Fram 1210, 1210A (2-1/4")	36
F94-6	-	Pure-Oil TM Individually bagged with gaskets	Fram 1210, 1210A (3-1/4")	6
F94-36	PM-12-RO	Pure-Oil TM Individually bagged with gaskets	Fram 1210, 1210A (3-1/4")	36

* UL Recognized Component



HOLDS TWICE AS MUCH!

Individual FILTER GASKETS on page F8

Please order by  No.

FILTER ELEMENTS

Ultra-10™ 10 MICRON FILTER ELEMENTS

- ▶ 10 Micron rating for super fine filtration
- ▶ Same type element as used in spin-ons
- ▶ Advanced collapse-proof design
- ▶ Changes any standard filter into a high performance filter

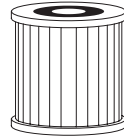

UL No. **F12-12**

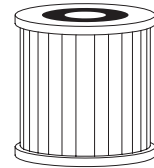

UL No. **F32-12**

UL No.	Description	Fits	QTY PKG
F12-12*	Ultra-10™ Indiv. bagged with gaskets	General 1A-25A; Unifilter 77; Westwood F10, F12, F15, F20, F25; Sid Harvey (Mitco) 264, 264F	12
F32-12*	Ultra-10™ Indiv. bagged with gaskets	General 2A-700A; Unifilter 99; Westwood F30, F32, F35, F65, F70; Sid Harvey (Mitco) 265, 265F	12

* UL Recognized Component

CLASSIC FELT™ STACKED SEGMENT ELEMENTS

- ▶ Premium quality precision cut wool felt
- ▶ Economical time proven classic design



UL No. **F15-36, -48**

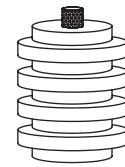

UL No. **F35-12, -24**

UL No.	Reference No.	Description	Fits	QTY PKG
F15-36*	A025	CLASSIC FELT™ Indiv. boxed with gaskets	General 1A-25A; Unifilter 77; Westwood F10, F12, F15, F20, F25; Sid Harvey (Mitco) 264, 264F	36
F15-48*	A025B	CLASSIC FELT™ Indiv. bagged with gaskets	Sid Harvey (Mitco) 264, 264F	48
F35-12*	-	CLASSIC FELT™ Indiv. bagged with gaskets	General 2A-700A; Unifilter 99; Westwood F30, F32, F35, F65, F70; Sid Harvey (Mitco) 265, 265F	12
F35-24*	A070	CLASSIC FELT™ Indiv. boxed with gaskets	Sid Harvey (Mitco) 265, 265F	24

* UL Recognized Component

COMMERCIAL ELEMENT for General Filters 2A-300

- ▶ Original **Hard to find** sealed can design

UL No.	Reference No.	Description	Fits	QTY PKG
F75	-	Original sealed can design, individually boxed with gaskets	General 2A-300	1
F75-12	A030			12

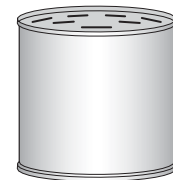

UL No. **F75, -12**

CLASSIC **YARN™** WOUND ELEMENTS

- ▶ Premium quality tightly wound yarn
- ▶ Economical time proven classic design

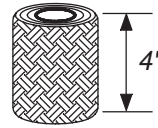

F84 (SERIES)
for Fulflo FB4

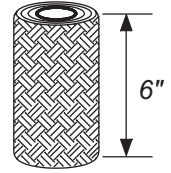

F85 (SERIES)
for Fulflo FB6

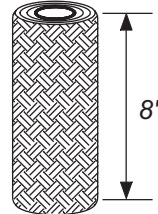

F86 (SERIES)
for Fulflo FB8

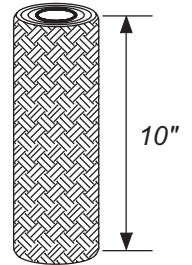

F87 (SERIES)
for Fulflo FB10

No.	Reference No.	Description	Fits Fulflo	QTY PKG
F84-30*	4FO-30	Bulk wo/gaskets	FB4	30
F84-36*	4FO-IB	Boxed w/gaskets	FB4	36
F84-48*	4FO-IBG	Bagged w/gaskets	FB4	48
F85-10	-	Bagged w/gaskets	FB6	10
F85-30	6FO-30	Bulk wo/gaskets	FB6	30
F86-6	-	Bagged w/gaskets	FB8	6
F86-30	8FO-30	Bulk wo/gaskets	FB8	30
F87-4	-	Bagged w/gaskets	FB10	4
F87-24	10FO-30	Bulk wo/gaskets	FB10	24

* UL Recognized Component

FUEL FILTER GASKETS

The same high quality gaskets used in Westwood's UL Listed filters

No.	Reference No.	Filter Manufacturer and Model	Description	Material	QTY PKG
F10-50	CG-25	General 1A-25A; Unifilter 77;	Cover	Rubber	100
F10-52	BG-25	Westwood F10, F12, F15, F20, F25;	Bolt	Fiber	100
F10-54	-	Sid Harvey (Mitco) 264, 264F	Vent	Fiber	100
F10-55	VG-25	Westwood S-254	Vent	Fiber	100
F30-50	CG-70	General 2A-700A; Unifilter 99;	Cover	Rubber	100
F10-52	BG-25	Westwood F30, F32, F35, F65, F70;	Bolt	Fiber	100
F10-54	-	Sid Harvey (Mitco) 265, 265F	Vent	Fiber	100
F75-50	CG-300	General 2A-300	Cover	Rubber	100
F75-56	LG-300		Lower Can	Rubber	100
F80-50	CG-B4	Fulflo FB4, FB6, FB8, FB10	Cover	Rubber	100
F80-52	BG-4		Nut	Fiber	100
F80-54	VG-4		Vent	Fiber	100
F90-50	CG-20	Firomatic C-40 (RC-20), C-50 (RC-30)	Cover	Rubber	100
F90-52	BG-20		Bolt	Fiber	100
F92-50	CG-2002	Purolator PF2002	Cover	Rubber	100
F92-52	BG-2002		Bolt	Fiber	100
F92-54	VG-2002		Vent	Fiber	100
F93-50	CG-1210	Fram 1210, 1210A	Cover	Rubber	100

Please order by No.

FILTER ELEMENTS



THE ONLY
UL APPROVED
replacement canisters

Another industry first! Westwood's new line of UL Recognized replacement canisters are UL approved for use on General 1A-25A, 2A-700A; Unifilter 77, Unifilter 99; Sid Harvey (Mitco) 264, 264F, 265, 265F; and Fulflo FB4.

Be Safe! Always look for the UL Recognized Component symbol



CANISTER UPGRADE KITS* Epoxy coated can, element, center bolt, gasket, fiber washers

 No.	Element Type	Upgrades
F10-5 F12-5 F15-5	Pure-Oil™ Ultra-10™ CLASSIC FELT™	General 1A-25A; Unifilter 77; Westwood F10, F12, F15, F20, F25, S-254; Sid Harvey (Mitco) 264, 264F
F30-5 F32-5 F35-5	Pure-Oil™ Ultra-10™ CLASSIC FELT™	General 2A-700A; Unifilter 99; Westwood F30, F32, F35; Sid Harvey (Mitco) 265, 265F
F80-5	Pure-Oil™ BIG GUY™	FULFLO FB4
F84-5	CLASSIC YARN™	

* All kits contain UL Recognized Component canisters and elements

Westwood GAUGE GLASS



HIGH QUALITY GLASS IN
5/8" AND 3/4"
 OUTSIDE DIAMETER (O.D.) SIZES

Length (inches)	STANDARD			HIGH PRESSURE		RED LINE			
	No.		Max. PSI* Water-Steam (see note 1.)	No.		Max. PSI* Water-Steam (see note 1.)	No.		Max. PSI* Water-Steam (see note 1.)
	5/8" 6/Pkg.	3/4" 12/Pkg.		5/8" 12/Pkg.			5/8" 12/Pkg.		
6	H1-6	-	210 - 100	-	-	-	-	-	-
8	H1-8	H2-8	210 - 100	H3-8	435 - 320	H4-8	370 - 285	H5-8	360 - 280
10	H1-10	H2-10	205 - 100	H3-10	420 - 315	H4-10	345 - 280	H5-10	340 - 275
12	H1-12	H2-12	200 - 100	H3-12	410 - 305	H4-12	335 - 280	H5-12	330 - 275
14	H1-14	H2-14	200 - 100	H3-14	390 - 295	H4-14	325 - 275	H5-14	320 - 270
16	H1-16	H2-16	195 - 100	H3-16	375 - 285	H4-16	315 - 270	H5-16	310 - 265
18	H1-18	H2-18	190 - 100	H3-18	360 - 280	H4-18	305 - 265	H5-18	300 - 260
20	H1-20	H2-20	185 - 100	H3-20	350 - 270	H4-20	290 - 265	H5-20	285 - 260
22	H1-22	H2-22	180 - 100	-	-	-	-	-	-
24	H1-24	H2-24	180 - 100	H3-24	320 - 255	H4-24	265 - 255	H5-24	260 - 250
26	-	-	-	-	-	-	-	-	-
28	-	-	-	-	-	-	-	-	-
30	H1-30	-	175 - NR	-	-	H4-30	235 - NR	-	-
36	-	H2-36	165 - NR	H3-36	245 - NR	H4-36	205 - NR	H5-36	200 - NR
48	-	H2-48	140 - NR	-	-	H4-48	165 - NR	-	-
60	-	-	-	-	-	H4-60	125 - NR	-	-
72	-	-	-	-	-	H4-72	90 - NR	-	-

note 1. Maximum Working Pressure (PSI): Water up to 150° F - Steam up to 425° F - NR = Not Recommended

GAUGE GLASS WASHERS - Standard and High Pressure

I.D. x O.D. x Thickness	Type	No.		No.		No.	
		Ref. No.	Ref. No.	Ref. No.	Ref. No.		
		Pkg. of 12		Pkg. of 50		Pkg. of 100	
9/16" x 13/16" x 1/4"	S*	H6-6	-	H6-8	-	H6-10	GGW-6812
3/4" x 15/16" x 1/4"		H6-11	-	H6-13	-	H6-15	GGW-7102
3/4" x 15/16" x 3/8"		H6-16	-	H6-18	-	H6-20	GGW-7103
3/4" x 15/16" x 1/2"		H6-21	-	H6-23	-	H6-25	GGW-7105
5/8" x 7/8" x 5/16"	HP**	H6-50	#3 GASKET	H6-52	-	H6-54	-
3/4" x 1-9/64" x 1/2"		H6-55	#33 GASKET	H6-57	-	H6-59	-



*S = Standard (Neoprene - Square cut) **HP = High Pressure (Lip mold)

Please order by No.



Take a look ...

GAUGE GLASS CUTTERS on page T15

Westwood STEAM BOILER PARTS

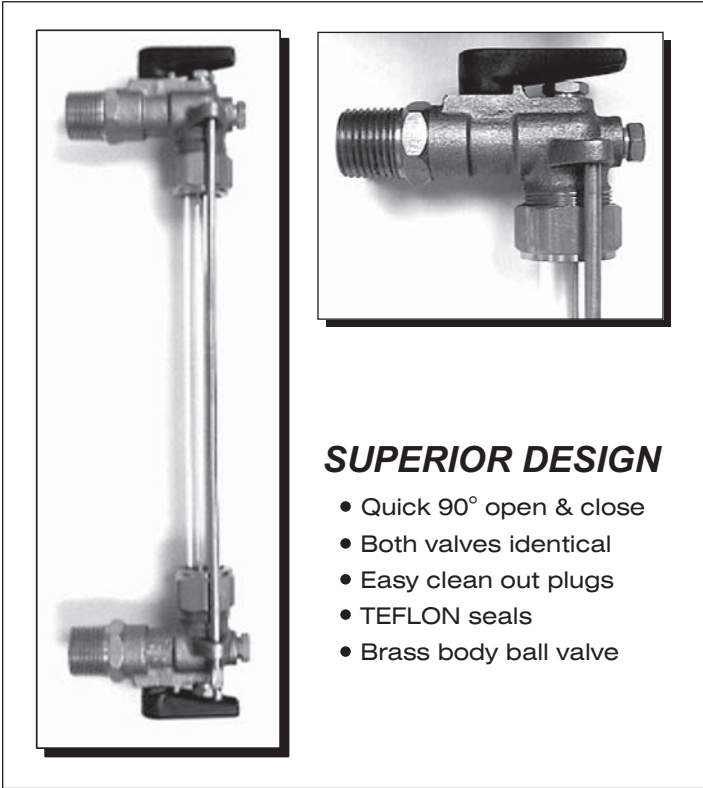

SUPERIOR DESIGN

- Quick 90° open & close
- Both valves identical
- Easy clean out plugs
- TEFLON seals
- Brass body ball valve

No. H7, -12

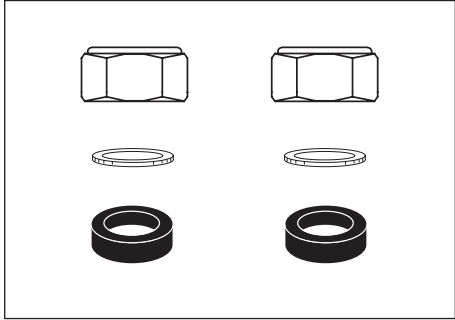

No. H7-23

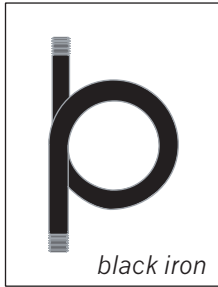

No. H7-50

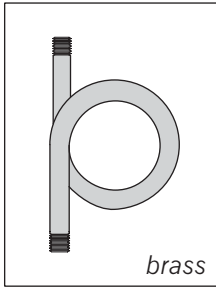

No. H7-52

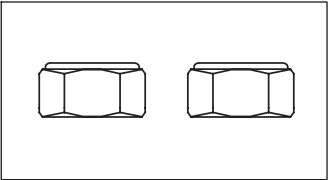

No. H7-20

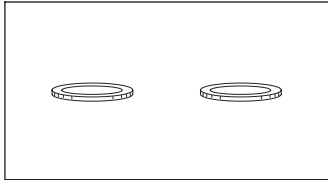

No. H7-21

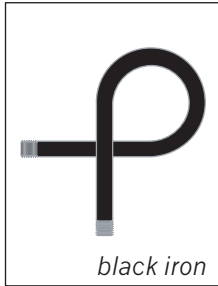

No. H7-55

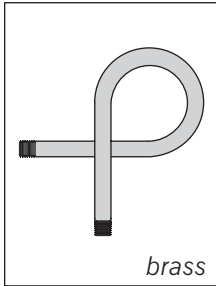

No. H7-57

STEAM BOILER PARTS

No.	Ref. No.	Description
H7	GV-22	Gauge Glass Set w/Quick Open 90° Ball Valve, TEFLON Seals, Brass, w/10" rods
H7-12	-	Gauge Glass Set w/Quick Open 90° Ball Valve, TEFLON Seals, Brass, w/12" rods and glass
H7-20	-	Gauge glass nut, package of 2
H7-21	-	Gauge glass nut friction washer, package of 6
H7-23	-	Gauge Glass Repair Kit, (2) ea. of nuts, friction washers, standard gauge glass washers
H7-50	-	Straight steam pig tail, black iron, 1/4"-NPT
H7-52	-	Straight steam pig tail, brass, 1/4"-NPT
H7-55	-	90° angle steam pig tail, black iron, 1/4"-NPT
H7-57	-	90° angle steam pig tail, brass, 1/4"-NPT

Westwood CIRCULATOR & FEEDER PARTS

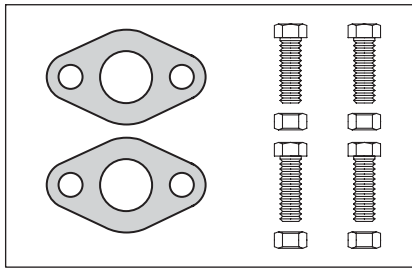

No. H10

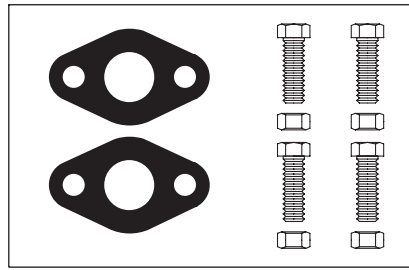

No. H10-1

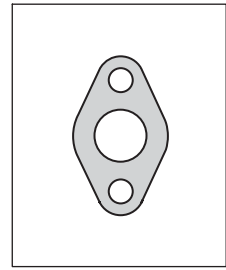

No. H15, -1

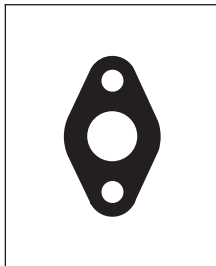

No. H16, -1

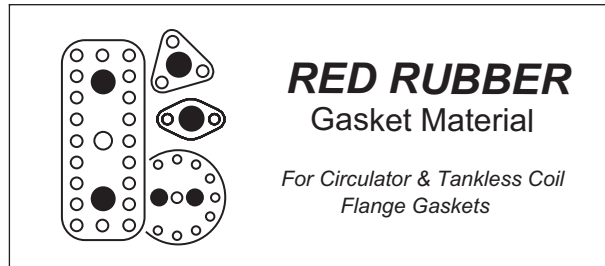

No. H21, -1

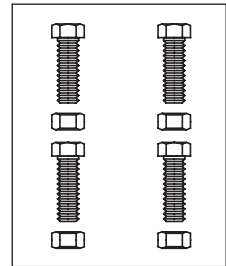

No. H22, -1

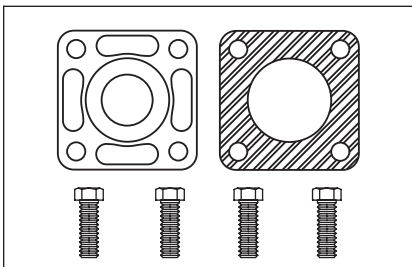

No. H23

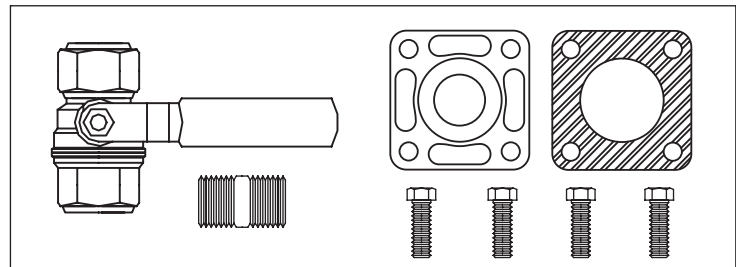



No. H23 -1

BOILER, CIRCULATOR, FEEDER PARTS

No.	Ref. No.	Description
H10	-	Circulator Flange Gasket Kit, (2) - RED rubber flange gaskets, (4) - 7/16"X1-3/4" bolts w/nuts
H10-1	-	Circulator Flange Gasket Kit, (2) - BLACK neoprene flange gaskets, (4) - 7/16"X1-3/4" bolts w/nuts
H15	-	Taco RED rubber flange gasket, package of 10 gaskets
H15-1	-	Taco RED rubber flange gasket, package of 100 gaskets
H16	-	Taco BLACK neoprene flange gasket, package of 10 gaskets
H16-1	-	Taco BLACK neoprene flange gasket, package of 100 gaskets
H21	-	Flange Gasket Material, Red Rubber, 1/8" Thick X 12" X 24" Sheet
H21-1	-	Flange Gasket Material, Red Rubber, 1/8" Thick X 18" X 36" Sheet
H21-36	-	Flange Gasket Material, Red Rubber, 1/8" Thick X 36" X 30' Roll
H22	-	B&G (small), Taco, Modern Flange Nuts and Bolts, (4) - 7/16" X 1-3/4"
H22-1	-	B&G (large) Flange Nuts and Bolts, (4) - 1/2" X 1-3/4"
H23	-	Dirt pocket cap for McDonnell & Miller (3/4"- NPT) w/gasket and (4) bolts
H23-1	-	Blow Down Kit for McDonnell & Miller (dirt pocket cap, full flow ball valve, nipple, gasket, (4) bolts

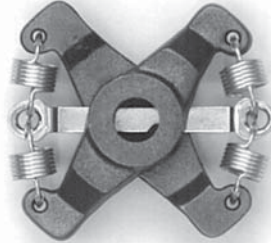
CIRCULATOR COUPLINGS**Westwood****COUPLINGS FOR B & G CIRCULATORS**

 No.	Ref. No.	Replaces B&G No.	Circ. HP	Description and Representative Picture
H24-10	PD-40	118705 (PZ-4291)	1/12, 1/6	Cast zinc, steel eyelet inserts, standard duty springs, for 1/2" shaft, individually boxed 
H24-15	JK-52	118705 (PZ-4291)	1/12, 1/6	Cast iron, heavy duty cross bar, springs reinforced, for 1/2" shaft, individually boxed 
H24-40	BG-33	118705 (PZ-4291)	1/12, 1/6	FLEXI-LINK spiral spring shock absorbing coupling, no moving parts, compensates for misalignment, quieter operation, for 1/2" shaft, individually bagged 
H24-60	WRM-858	118723 (PZ-12291)	1/4, 1/3	Cast iron, heavy duty cross bar, heavy duty springs, for 1/2" shaft, individually bagged 
H24-62	WRM-798	118473 (PDZ-12291)	1/2, 3/4	Cast iron, heavy duty cross bar, heavy duty springs, for 1/2" shaft, individually bagged 



Take a look . . .









More parts for CIRCULATORS on page H3

H4

rev. 5-1-05

Please order by  No.

TRIDICATOR, STEAM, COMBINATION, ALTITUDE, TEMPERATURE

 No.	Ref. No.	Type	Mount	Face	Shank	Insert.	Range / Description	Representative Picture	
H25 H25-1 H25-2 H25-3	PTA-224C PTA-234C PTA-322C PTA-322L	Tridicator	1/4" CBM 1/4" CBM 1/2" CBM 1/2" LM	2-1/2" 2-1/2" 3-1/4" 3-1/4"	1-3/4" 3" 1-3/4" 1-3/4"	7/8" 7/8" 1-1/8" 3/4"	70°- 320°F, 20°- 160°C 0 - 75 PSI, 0 -170 Ft H ₂ O		
H25-10 H25-12	5495 5549	Steam gauge	1/4" LM 1/4" LM	3-1/2" 4-1/2"	- -	- -	30" Hg. - 30 PSI 30" Hg. - 30 PSI		
H25-15 H25-16 H25-17 H25-18 H25-19 H25-20	135393 135392 144435 144434 144826 144827	PT 1088 Combination temperature and pressure gauge	1/4" CBM 1/4" CBM 1/2" LBM 1/2" LM 1/2" LM 1/2" LBM	2-1/2" 2-1/2" 3-1/2" 3-1/2" 3-1/2" 3-1/2"	3" 2-1/4" 3-3/4" 3-1/4" 3-1/4" 3-3/4"	1-3/4" 1-3/4" 2" 2" 2" 2"	60°- 320°F, 75 PSI 60°- 320°F, 75 PSI 60°- 260°F, 50 PSI 60°- 260°F, 50 PSI 80°- 320°F, 200 PSI 80°- 320°F, 200 PSI		
H25-30 H25-31 H25-35	46775 11498 11937	Altitude & water level gauge	1/4" LM 1/4" LM 1/4" LM	3-1/2" 4-1/2" 4-1/2"	- - -	- - -	100 PSI, 0 - 231 FT 100 PSI, 0 - 231 FT 0 - 390 FT		
H25-50* H25-51** H25-52* H25-53**	T-571 T-571 Brass HWT-A T-572 Brass	Hot water glass tube thermometer	1/2" LM 1/2" LM 1/2" LBM 1/2" LBM	- - - -	2" 2" 2" 2"	1-3/8" 1-3/8" 1-3/8" 1-3/8"	40°- 260°F, Vertical 40°- 260°F, Vertical 20°- 280°F, Vertical 20°- 280°F, Vertical		
		*Steel immersion well **Brass immersion well							
H25-54 H25-55	T-1050 T-1051	Hot water thermometer	1/2" LM 1/2" LBM	3-1/2" 3-1/2"	3" 3-3/4"	2" 2"	60°- 260°F 60°- 260°F		
H25-90	HWT-D	Dial Thermometer	1/2" CBM	2-1/2"	1-3/4"	1-1/4"	30°- 250°F		



MORE GAUGES in Service Supplies Section starting on page S10

Please order by  No.

MISC. PARTS & IMMERSION WELLS

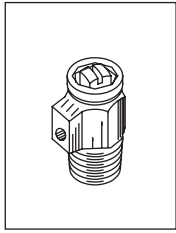

W/P No. H30

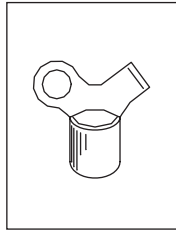

W/P No. H30-1

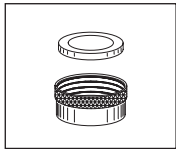

W/P No. H31

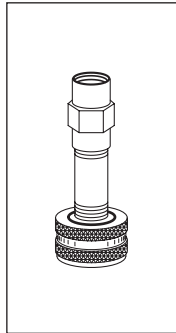

W/P No. H35

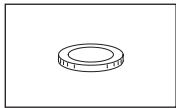

W/P No. H31-1

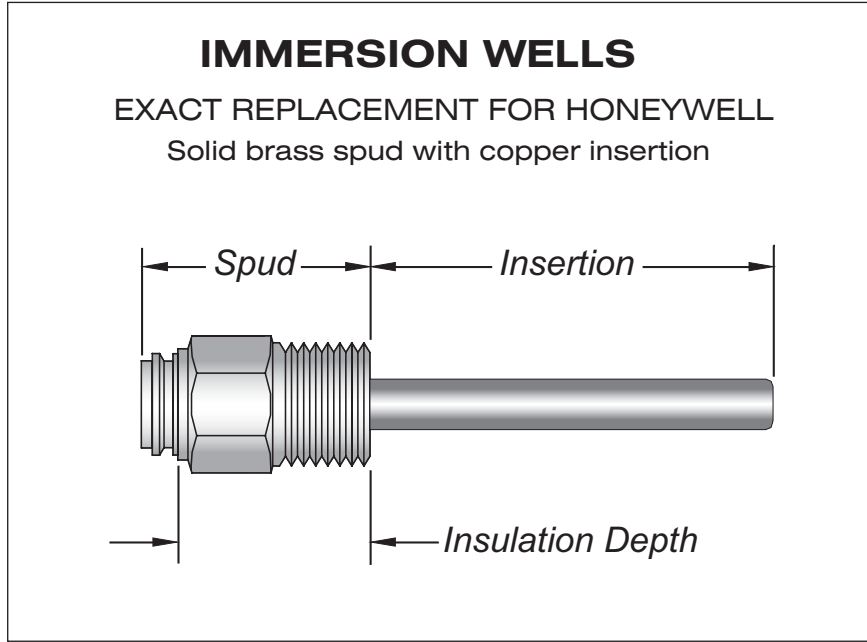

W/P No. H50 (Series)

RADIATOR VENT & KEY, HOSE CAP, HOSE ADAPTOR

W/P No.	Thread Size	Description	QTY PKG
H30	1/8" - NPT	Radiator bleed valve, plated finish, coin/key/screwdriver operated	6
H30-1	-	Radiator bleed key, square socket and screwdriver	6
H31	Garden hose (F)	Garden hose cap, brass with washer	10
H31-1	-	Garden hose washer only	10
H35	Garden hose (F) x 1/4" - NPT (F or M)	Gauge adaptor for measuring water pressure	1

IMMERSION WELLS - Brass spud, copper insertion

W/P No.	Replaces Honeywell	Pipe Size (Male NPT)	Insertion Diameter	Insertion Length	Insulation Depth (ins.)	Comments
H50	121371A 123869A	1/2"	3/8"	3"	1-1/2"	Used with: L4006, L6006, L8124, L8148, R8182D, E, F
H50-1	121371B 123870A	3/4"	3/8"	3"	1-1/2"	Used with: L4006, L6006, L8124, L8148, R8182D, E, F
H50-2	122555A	3/4"	3/8"	3"	4-1/2"	Long spud for water heaters
H50-3	122555E	3/4"	3/8", 5/8"	3"	4-1/2"	Plastic sleeve on insertion
H50-4	121371M	3/4"	3/8"	3"	3"	Long spud for water heaters
H50-5	121371L	1/2"	3/8"	3"	3"	Long spud for water heaters

Westwood LIQUID LEVEL PROBES for FULTON BOILERS

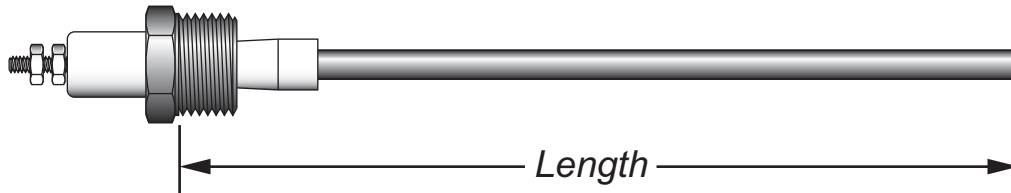

COMPLETE REPLACEMENT PROBE KITS (Kits contain 1 each of Probe A, B, C, D)

W/P No.	Miniature 2 & 4 HP		Regular 6 to 30 HP		Series E	
	Prior to April 5, 1965	After April 5, 1965	Prior to August 1, 1964	After August 1, 1964	4 HP	6 to 100 HP
	H75	H76	H75-1	H76-1	H76-2	H76-3
Ref. No.	FP3-M1	FP2-M2	FP3-R1	FP2-R2	FP2-E1	FP2-E2
Thread	3/8"-NPT	1/2"-NPT	3/8"-NPT	1/2"-NPT	1/2"-NPT	1/2"-NPT
Probe A	H75-850	H76-950	H75-625	H76-725	H76-950	H76-725
Probe B	H75-1000	H76-1100	H75-825	H76-925	H76-1100	H76-925
Probe C	H75-1125	H76-1225	H75-975	H76-1075	H76-1225	H76-1075
Probe D	H75-1200	H76-1300	H75-1325	H76-1425	H76-1300	H76-1625

INDIVIDUAL REPLACEMENT PROBES

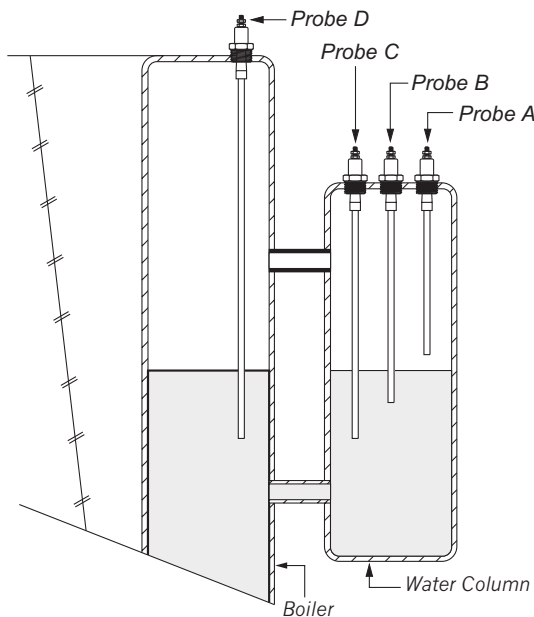

3/8"- NPT		1/2"- NPT	
W/P No.	Length	W/P No.	Length
H75-625	6-1/4"	H76-725	7-1/4"
H75-825	8-1/4"	H76-925	9-1/4"
H75-850	8-1/2"	H76-950	9-1/2"
H75-975	9-3/4"	H76-1075	10-3/4"
H75-1000	10"	H76-1100	11"
H75-1125	11-1/4"	H76-1225	12-1/4"
H75-1200	12"	H76-1300	13"
H75-1325	13-1/4"	H76-1425	14-1/4"
		H76-1625	16-1/4"

Probe A - Pump off
 Probe B - Pump on
 Probe C - LWC in water column
 Probe D - LWC in boiler

Please order by No.



MORE LIQUID LEVEL PROBES on pages E25 - E27

WEIL McLAIN BOILER PARTS**WEIL-McLAIN****GENUINE REPLACEMENT PARTS**

By specifying Genuine Weil-McLain parts, you are assured of a perfect, no hassle fit and parts that perform as expected.

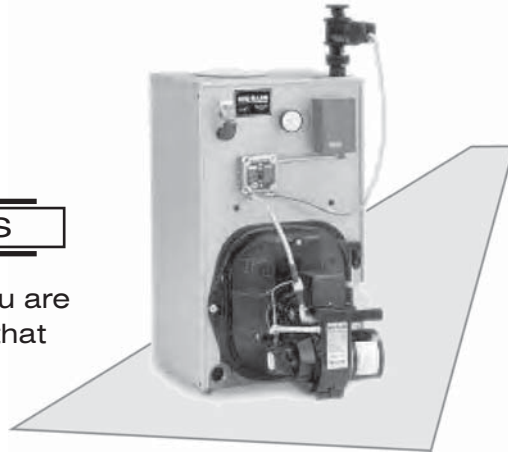
**WEIL McLAIN BOILER & BURNER PARTS**

 No.	Weil McLain Number	Description
<i>E5-598*</i>	-	Weil-McLain burner electrode
<i>E5-598A*</i>	-	Weil-McLain burner electrode w/ leads
<i>E5-598B*</i>	-	Weil-McLain burner electrode leads only
<i>H85-10</i>	382-200-448	Gold control module
<i>H85-12</i>	510-312-166	Trans. relay with recp.
<i>H85-14</i>	510-312-167	Plug in relay
<i>H85-16</i>	510-312-250	Temperature control
<i>H85-18</i>	510-312-312	Blower assem. HE/VHE
<i>H85-20</i>	510-350-105	Spill switch, 24 VAC
<i>H85-22</i>	510-350-223	Plug in relay, 24 VAC
<i>H85-24</i>	511-044-256	Gas valve, 3/4"-NPT, CG7-8
<i>H85-26</i>	511-044-284	Gas valve, 1/2"-NPT
<i>H85-28</i>	511-044-285	Gas valve, 3/4"-NPT
<i>H85-30</i>	511-044-360	Gas valve EG-SPDN
<i>H85-32</i>	511-330-080	CGI natural gas pilot assem.
<i>H85-34</i>	511-330-111	Relight control
<i>H85-36</i>	511-330-112	Burner ignition cable
<i>H85-38</i>	511-330-148	Ignition kit
<i>H85-40</i>	511-330-186	Pilot burner
<i>H85-42</i>	511-330-218	Burner assem. with cable
<i>H85-44</i>	511-724-255	Thermocouple (Q309B 1177), 36"
<i>H85-46</i>	511-724-277	Plug in sensor
<i>H85-48</i>	511-724-278	Mercury flame detector
<i>H85-50</i>	512-050-230	Roll out switch
<i>H85-52</i>	512-200-000	Steel burner tube
<i>H85-54</i>	512-200-077	CGA main burner tube
<i>H85-56</i>	560-528-958	Pilot orifice
<i>H85-58</i>	560-742-860	Pilot tubing
<i>H85-60</i>	592-800-005	Elastomer seals for 88, 9"
<i>H85-62</i>	592-800-010	Elastomer seals for EG66, 3"
<i>H85-64</i>	635-600-062	Drywell and "O" ring
<i>H85-66</i>	633-900-102	Thermostat kit with cover plate
<i>H85-68</i>	633-900-130	Thermostat kit, res.

*Manufactured by Westwood. For more information, see page E14

In addition to these parts, many other Weil McLain parts are available.
Consult the factory for price and availability of other part numbers.

H8

rev. 5-1-05

Please order by  No.

BRAZED PLATE HEAT EXCHANGERS

For radiant heating, domestic hot water, snow melting, pool heating, steam zoning, fuel pre-heating, and general shell & tube replacement



- ▶ All 316 Stainless Steel w/copper brazing
- ▶ Maximum pressure 450 PSI, temperature 365°F
- ▶ UL Listed (US and Canada), CSA Approved
- ▶ Mounting brackets and insulation kits available



GENERAL APPLICATION Many more sizes and styles available. Consult the factory for detailed specifications

 No.	No. of Plates	BTUH (1,000's)*				Pipe Connections (Male NPT)	Approximate Dimensions & Weight			
		Radiant Heat	Heat Zoning	Domestic Hot Water	Snow Melting		Height (in.)	Width (in.)	Depth (in.)	Weight (lbs.)
H101-10	10	38	38	113	50	3/4"	8	2-7/8	1-1/2	2.8
H101-14	14	52	53	155	70	3/4"	8	2-7/8	1-7/8	3.2
H101-20	20	72	73	220	98	3/4"	8	2-7/8	2-3/8	3.8
H101-30	30	103	103	310	140	3/4"	8	2-7/8	3-5/16	5.0
H103-14	14	85	87	255	115	1"	6-3/4	4-7/8	1-7/8	4.5
H103-20	20	120	122	360	160	1"	6-3/4	4-7/8	2-3/8	5.3
H103-40	40	230	229	685	310	1"	6-3/4	4-7/8	4-1/4	7.8
H104-10	10	41	41	122	55	1"	13	4-7/8	1-1/2	6.2
H104-14	14	57	58	170	76	1"	13	4-7/8	1-7/8	7.2
H104-24	24	97	97	290	130	1"	13	4-7/8	2-3/4	9.8
H104-30	30	120	122	360	160	1"	13	4-7/8	3-5/16	11.4
H104-50	50	195	195	585	260	1"	13	4-7/8	5-1/4	16.6

* Ratings @ temperatures shown in Table 1.

DOUBLE WALL VENTED - Protects against cross fluid contamination

 No.	No. of Plates	BTUH (1,000's)*				Pipe Connections (Male NPT)	Approximate Dimensions & Weight			
		Radiant Heat	Heat Zoning	Domestic Hot Water	Snow Melting		Height (in.)	Width (in.)	Depth (in.)	Weight (lbs.)
H105-14	14	48	50	147	66	1"	20-7/8	4-7/8	1-7/8	11.8
H105-20	20	70	71	210	95	1"	20-7/8	4-7/8	2-3/8	15.0
H105-30	30	105	106	310	140	1"	20-7/8	4-7/8	3-5/16	20.3
H105-50	50	170	171	510	230	1"	20-7/8	4-7/8	5-1/4	31.0
H105-80	80	255	260	770	340	1"	20-7/8	4-7/8	8	47.0
H105-100	100	300	305	910	410	1"	20-7/8	4-7/8	10	57.5

* Ratings @ temperatures shown in Table 1.

Please order by  No.

HEAT EXCHANGERS

BRAZED PLATE HEAT EXCHANGERS (CONTINUED)

HIGH CAPACITY

 No.	No. of Plates	BTUH (1,000's)*				Pipe Connections (Male NPT)	Approximate Dimensions & Weight			
		Radiant Heat	Heat Zoning	Domestic Hot Water	Snow Melting		Height (in.)	Width (in.)	Depth (in.)	Weight (lbs.)
H107-20	20	265	270	785	350	2"	20-7/8	10-5/8	2-3/8	38.6
H107-24	24	310	320	940	420	2"	20-7/8	10-5/8	2-3/4	43.8
H107-30	30	380	390	1,150	520	2"	20-7/8	10-5/8	3-5/16	51.8
H107-40	40	500	508	1,500	670	2"	20-7/8	10-5/8	4-1/4	65.0
H107-50	50	590	602	1,785	800	2"	20-7/8	10-5/8	5-1/4	78.2
H107-60	60	685	680	2,000	920	2"	20-7/8	10-5/8	6-3/16	91.4
H107-100	100	885	885	2,600	1,200	2"	20-7/8	10-5/8	10	144.2
H107-120	120	930	925	2,750	1,270	2"	20-7/8	10-5/8	11-7/8	170.6
H107-150	150	960	950	2,850	1,330	2"	20-7/8	10-5/8	14-3/4	210.2

* Ratings @ temperatures shown in Table 1.

AEROFLEX PRESSURE SENSITIVE INSULATION KITS

No. of Plates	Heat Exchanger Series				
	H101	H103	H104	H105	H107
10	H111-10	—	H114-10	—	—
14	H111-14	H113-14	H114-14	H115-14	—
20	H111-20	H113-20	—	H115-20	H117-20
24	—	—	H114-24	—	H117-24
30	H111-30	—	H114-30	H115-30	H117-30
40	—	H113-40	—	—	H117-40
50	—	—	H114-50	H115-50	H117-50
60	—	—	—	—	H117-60
80	—	—	—	H115-80	—
100	—	—	—	H115-100	H117-100
120	—	—	—	—	H117-120
150	—	—	—	—	H117-150



Many more sizes and styles of heat exchangers are available, including models suitable for salt water applications.

TABLE 1 - Temperatures for BTUH ratings shown

Heat Exchanger Connected to	Heat Exchanger			
	Input Side (boiler)		Output Side ¹	
	In	Out	In	Out
Radiant Heat	180°F	140°F	90°F	110°F
Heat Zoning	180°F	160°F	150°F	170°F
Domestic Hot Water	180°F	120°F	60°F	120°F
Snow Melting ²	180°F	140°F	100°F	130°F

¹ Output side pressure drop ≈ 2 psi

² 40% Glycol in melt loop

NOTE

The heat exchanger BTUH ratings shown are very conservative, and were derived using familiar system temperatures, flow rates, and pressure drops.

For each heat exchanger, the BTUH output can be greatly increased by choosing different system design temperatures and increasing flow rates.

MAX-DRIVE

V-BELTS

OIL & HEAT RESISTANT

Rugged polyester cord and neoprene construction with specially treated natural and synthetic elastomeric compounds make the **MAX-DRIVE** V-belt the ideal choice for heavy loads under extreme heat or for constant exposure to oil.

When replacing a V-belt, always clean pulley grooves and check that shafts are parallel and pulley alignment is correct.

Standard V-Belt Types			
	3L	4L	5L
W	3/8"	1/2"	21/32"



Outside Length (inches)	 No.		
	3L	4L	5L
20	S30-20	S40-20	-
21	S30-21	S40-21	-
22	S30-22	S40-22	-
23	S30-23	S40-23	S50-23
24	S30-24	S40-24	S50-24
25	S30-25	S40-25	S50-25
26	S30-26	S40-26	S50-26
27	S30-27	S40-27	S50-27
28	S30-28	S40-28	S50-28
29	S30-29	S40-29	S50-29
30	S30-30	S40-30	S50-30
31	S30-31	S40-31	S50-31
32	S30-32	S40-32	S50-32
33	S30-33	S40-33	S50-33
34	S30-34	S40-34	S50-34
35	S30-35	S40-35	S50-35
36	S30-36	S40-36	S50-36
37	S30-37	S40-37	S50-37
38	S30-38	S40-38	S50-38
39	S30-39	S40-39	S50-39

Outside Length (inches)	 No.		
	3L	4L	5L
40	S30-40	S40-40	S50-40
41	S30-41	S40-41	S50-41
42	S30-42	S40-42	S50-42
43	S30-43	S40-43	S50-43
44	S30-44	S40-44	S50-44
45	S30-45	S40-45	S50-45
46	S30-46	S40-46	S50-46
47	S30-47	S40-47	S50-47
48	S30-48	S40-48	S50-48
49	S30-49	S40-49	S50-49
50	S30-50	S40-50	S50-50
51	S30-51	S40-51	S50-51
52	S30-52	S40-52	S50-52
53	S30-53	S40-53	S50-53
54	S30-54	S40-54	S50-54
55	S30-55	S40-55	S50-55
56	S30-56	S40-56	S50-56
57	S30-57	S40-57	S50-57
58	S30-58	S40-58	S50-58
59	S30-59	S40-59	S50-59
60	S30-60	S40-60	S50-60



SPECIAL FOR LENNOX BURNER

 No.	Ref. No.	Lennox Burner No.	Belt Type	Outside Length
S20-16	VB-1049	DV-1049	2L - Cogged	16"

COMBUSTION CHAMBERS**Westwood** ceramic fibre chambers

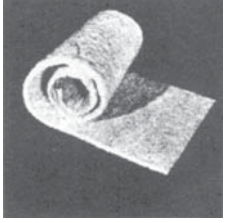

SOUND ABSORBING • RED HOT IN SECONDS • FIRES DRY • 2,300° - 3,000°F

WET COMBUSTION CHAMBER LINERS

 No.	Ref. No.	Type	GPH	Description and Representative Picture	
S70-9 S70-10 S70-11 S70-12 S70-13 S70-15	#9 #10 #11 #12 #13 #15	Wet*	Westwood Round - Preshaped	.50 - .75 .85 - 1.00 1.10 - 1.25 1.35 - 1.50 1.65 - 1.85 2.00 - 2.50	9" diameter, 12" high 10" diameter, 12" high 11" diameter, 12" high 12" diameter, 12" high 13" diameter, 14" high 15" diameter, 14" high 
S70-25 S70-27	#135 #200	Wet*	Westwood Rect. - Preshaped	.75 - 1.35 1.35 - 2.00	14" x 11" x 12" 14" x 12" x 12" 
S70-30 S70-35 S70-40 S70-45	#1 #2 #3 #4	Wet*	Westwood Flat sheet(s)	1.25 2.50 2.65 1.25	(1) - 14" x 48" (1) - 14" x 48" (1) - 16" x 16" (1) - 16" x 48" (1) - 16" x 16" (1) - 16" x 48" 

*Sealed in a plastic bag and individually boxed

J-M Cerafelt™
Dry Refractory Liners**DRY COMBUSTION CHAMBER LINERS**

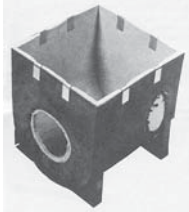
 No.	Ref. No.	Type	GPH	Description and Representative Picture	
S70-50 S70-51 S70-52	141608 141612 144824	Dry	Cerafelt blanket	- - -	1/4" x 16" x 8 ft. 1/4" x 16" x 12 ft. 1/4" x 48" x 25 ft. 
S70-60	SS Kit	Dry	Cerafelt SS Kit (For lining burned out stainless steel combustion chambers)	.50 - 1.75	(1) - 14" x 48" (1) - 16" x 33" (8) - Stainless Steel Clips 

Westwood

HIGH TEMPERATURE ROPE*NON-ASBESTOS • KNITTED FIBERGLASS*

This strong, flexible, resilient knit-braided rope is ideal for industrial boilers, cast iron boilers, wood burning stoves, ovens, and furnaces. Will not "bloom" or untwist like braided twisted glass rope. Made of 100% texturized fiberglass, it will not burn or support combustion. Resists temperatures to 1,000° F.

**NON-ASBESTOS HIGH TEMPERATURE ROPE**

 No.	Type	Dimension	Length
S70-101	Round	1/4" diameter	10 ft.
S70-102	Round	1/4" diameter	25 ft.
S70-104	Round	3/8" diameter	10 ft.
S70-106	Round	3/8" diameter	25 ft.
S70-108	Round	1/2" diameter	10 ft.
S70-110	Round	1/2" diameter	25 ft.
S70-111	Round	3/4" diameter	10 ft.
S70-112	Round	3/4" diameter	25 ft.
S70-114	Round	1" diameter	10 ft.
S70-116	Round	1" diameter	25 ft.
S70-140*	Flat	1" wide x 1/8" thick	25 ft.
S70-150*	Flat	2" wide x 1/8" thick	25 ft.

* Available with pressure sensitive adhesive backing

Other types and sizes of high temperature materials are available on special order. Consult the factory for price and availability.

ONE PIECE COUPLINGS

Westwood

ONE PIECE MOTOR COUPLINGS

HEAVY DUTY FOR GENERAL USE ON BURNERS AND MOTOR DRIVEN EQUIPMENT



Rugged, precision machined end pieces are held in place by heavy steel collars. Set screws at each end insure that there is no slippage on the shaft flats. Quiet, noise and vibration absorbing, these premium couplings out-perform conventional couplings where misalignment exists or where punishing service is the norm. Available for 1/2" x 7/16" and 1/2" x 5/16" shaft sizes, or 7/16" shaft x spline socket.

ONE PIECE COUPLINGS

Length	 No.		
	1/2" x 7/16"	1/2" x 5/16"	7/16" x Spline
2"	S80-200*	S81-200*	-
2-3/8"	S80-237	S81-237*	-
2-1/2"	S80-250*	S81-250*	-
3"	S80-300*	S81-300*	S82-300*
3-1/4"	S80-325	S81-325*	S82-325
3-3/8"	S80-337	S81-337*	S82-337
3-1/2"	S80-350*	S81-350	S82-350
4"	S80-400*	S81-400	S82-400*
4-1/2"	S80-450*	S81-450	S82-450
5"	S80-500	S81-500	S82-500*
5-1/2"	S80-550	S81-550	S82-550
6"	S80-600	S81-600	S82-600
6-1/2"	S80-650	S81-650	S82-650
7"	S80-700	S81-700	S82-700
7-1/2"	S80-750	S81-750	S82-750
8"	S80-800	S81-800	S82-800

* Included in One Piece Coupling Kit No. S83-200, shown below

REDUCER BUSHING & COUPLING KIT

 No.	Ref. No.	Description
S83-10	Reducer Bushing	5/16" I.D. x 7/16" O.D. bushing
S83-200	1890	One piece coupling kit containing those couplings marked with an asterisk above, plus (6) S83-10 reducer bushings

Westwood
Nylo-Flex™ BURNER COUPLINGS

EASILY INSTALLED 3 PIECE COUPLING • NO SET SCREWS



Cut

Assemble

Chosen by top service professionals and original equipment (oem) burner manufacturers. Three piece design allows for custom fit in all installations.

Nylo-Flex™ COMPONENTS

 No.	Reference No.	Description and Representative Picture
S85-6	6" Nyloshaft	Nylo-Flex™ 6" Nyloshaft center piece
S85-10	10" Nyloshaft	Nylo-Flex™ 10" Nyloshaft center piece
S85-12	12" Nyloshaft	Nylo-Flex™ 12" Nyloshaft center piece
S85-15	15" Nyloshaft	Nylo-Flex™ 15" Nyloshaft center piece
S85-30	30" Nyloshaft	Nylo-Flex™ 30" Nyloshaft center piece
S85-100	Red End Fitting	Nylo-Flex™ 5/16" shaft size end piece, RED
S85-110	Blue End Fitting	Nylo-Flex™ 7/16" shaft size end piece, BLUE
S85-120	Black End Fitting	Nylo-Flex™ 1/2" shaft size end piece, BLACK
S85-130	TA	Nylo-Flex™ Torrington adapter, 1/2" shaft

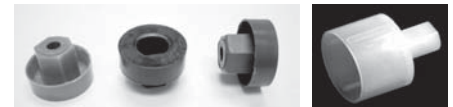

Nylo-Flex™ OEM SPEC COUPLINGS*

Two end pieces, plus a Nyloshaft correctly cut to OEM specs

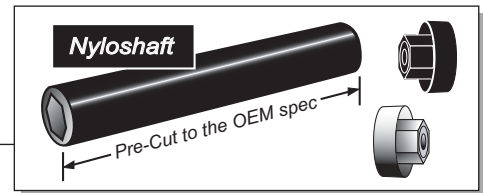

 No.	Description
S85-200	Nylo-Flex™ Pre-cut Coupling for Beckett AF (2454), 1/2" & 5/16" Ends, 3-13/32" Nyloshaft
S85-210	Nylo-Flex™ Pre-cut Coupling for Beckett (2290), 1/2" & 5/16" Ends, 2-7/8" Nyloshaft
S85-220	Nylo-Flex™ Pre-cut Coupling for Carlin 99-100 (99RA10208), 1/2" & 5/16" Ends, 2-3/16" Nyloshaft
S85-222	Nylo-Flex™ Pre-cut Coupling for Carlin (99RA5220), 1/2" & 7/16" Ends, 3-1/16" Nyloshaft
S85-223	Nylo-Flex™ Pre-cut Coupling for Carlin CRDA (1020J), 1/2" & 7/16" Ends, 2-3/4" Nyloshaft
S85-224	Nylo-Flex™ Pre-cut Coupling for Carlin 1020 (A Pump), 1/2" & 5/16" Ends, 2-11/32" Nyloshaft
S85-225	Nylo-Flex™ Pre-cut Coupling for Ducane (B1011503), 1/2" & 5/16" Ends, 3-13/16" Nyloshaft
S85-227	Nylo-Flex™ Pre-cut Coupling for Lennox (65A4101), 1/2" & 5/16" Ends, 3-5/8" Nyloshaft
S85-229	Nylo-Flex™ Pre-cut Coupling for Wayne E (13279), 1/2" & 5/16" Ends, 4-5/16" Nyloshaft
S85-230	Nylo-Flex™ Pre-cut Coupling for Wayne (13424), 1/2" & 5/16" Ends, 3-13/16" Nyloshaft
S85-231	Nylo-Flex™ Pre-cut Coupling for Wayne M, 1/2" & 5/16" Ends, 3-1/4" Nyloshaft

* Each coupling individually sealed in a plastic bag and labeled

Please order by  No.

 Take a look . . .

Nylo-Flex™ COUPLING KITS on page S6

NYLO-FLEX & KUT-A-SYZ KITS

Westwood
Nylo-Flex™ BURNER COUPLINGS

**COUPLING
KITS**

**THE WIDEST SELECTION TO
MEET ALL SERVICING NEEDS**



No. S85-550



No. S85-560



No. S85-525

Nylo-Flex™ COUPLING KITS

No.	Ref. No.	Quantity of End Pieces			Nyloshaft Quantity & Length	S85-130 Torrington Adapter	T100-300 Coupler Popper™	T100-310 Coupling Cutter	Molded Plastic Box
		1/2"	7/16"	5/16"					
S85-500	#88	1	1	1	1 - 6"	-	-	-	-
S85-502	-	1	1	1	1 - 12"	-	-	-	-
S85-510	#99A	2	2	1	1 - 6"	-	-	-	-
S85-520	#101	2	1	2	1 - 6"	-	-	-	-
S85-525	-	8	6	5	6 - 6"	-	-	-	-
S85-530	#1240	16	8	8	8 - 9"	-	-	-	YES
S85-540	#1240C	16	8	8	8 - 9"	-	-	-	-
S85-550	#1242	16	8	8	8 - 9"	-	YES	YES	YES
S85-560	#1250	12	12	5	12 - 6"	5	-	-	-
S85-570	#1251	12	12	5	12 - 6"	5	YES	-	-



KUT-A-SYZ™ COUPLINGS - Components & Kits



No.	Ref. No.	Description	A	B
S86-100	2607	7" rubber shaft	1	3
S86-102	2614	14" rubber shaft	-	-
S86-104	2621	Metal end piece, for 5/16" shaft	1	2
S86-106	2622	Metal end piece, for 7/16" shaft	1	2
S86-108	2623	Metal end piece, for 1/2" shaft	2	2
S86-110	2624	Metal end piece, for 5/8" shaft	1	1
S86-112	2630	Metal splined hub adapter	1	2
S86-120	#100	Kit, items listed in Column A		
S86-130	#200	Kit, items listed in Column B, plus Allway saw, metal tool box		



Westwood
BURNER TUNE - UP KITS

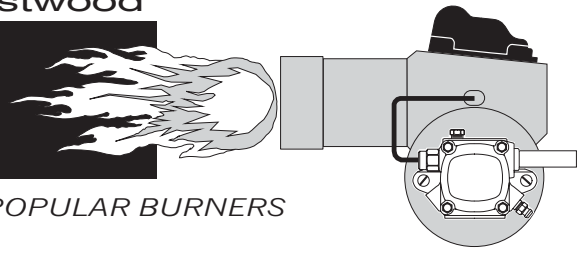

A REAL TIME SAVER FOR THE MOST POPULAR BURNERS

TUNE-UP & ELECTRODE KITS

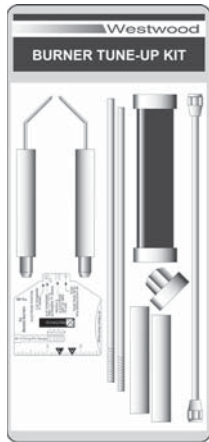

No. S88-10

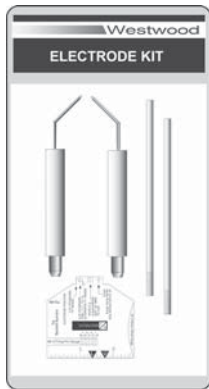

No. S88-20

<input checked="" type="checkbox"/> No.	Ref. No.	Description
S88-10	BK5780	TUNE-UP KIT for Beckett AF, AR, SF, SR (up to 9" air tube)
		2 - Electrode assemblies 1 - 12" oil line assembly 1 - Pump coupling kit
S88-12	NBK5780	TUNE-UP KIT for Beckett AF, AR, SF, SR (up to 9" air tube)
		2 - Electrode assemblies 1 - 12" oil line assembly 1 - Pump coupling kit
S88-14	BK5782	TUNE-UP KIT for Beckett AF, AR, SF, SR (over 9" air tube)
		2 - Electrode assemblies 1 - 12" oil line assembly 2 - E5-2M4 insulators
S88-16	NBK5782	TUNE-UP KIT for Beckett AF, AR, SF, SR (over 9" air tube)
		2 - Electrode assemblies 1 - 12" oil line assembly 2 - E5-2M4 insulators 1 - Pump coupling kit
S88-20	W5780	ELECTRODE KIT for Beckett AF, SF, SR (up to 9" air tube)
		2 - Electrode assemblies 2 - Extension rods with nuts
S88-22	W5781	ELECTRODE KIT for Beckett A and S (up to 9" air tube)
		2 - Electrode assemblies 2 - Extension rods with nuts
S88-24	W5782	ELECTRODE KIT for Beckett AF, SF, SR (over 9" air tube)
		2 - Electrode assemblies 2 - Extension rods with nuts 2 - Insulators
S88-26	W5783	ELECTRODE KIT for Beckett AQ and S (over 9" air tube)
		2 - Electrode assemblies 2 - Extension rods with nuts
S88-28	W5940	ELECTRODE KIT for Beckett MB and MD (up to 9" air tube)
		2 - Electrode assemblies 2 - Extension rods with nuts
S88-30	51212	ELECTRODE KIT for Beckett CF1400
		2 - Electrode assemblies 2 - Extension rods with nuts

Packaging may vary from that shown

Please order by No.

BURNER TUNE UP KITS

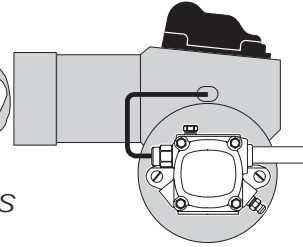

A REAL TIME SAVER FOR THE MOST POPULAR BURNERS

TUNE-UP & ELECTRODE KITS (Continued)

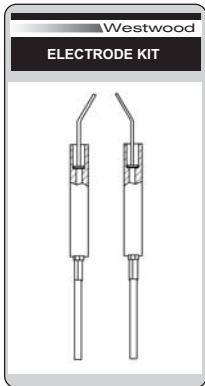

No. S88-36

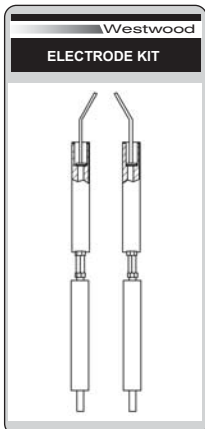

No. S88-38



No. S88-74

 No.	Ref. No.	Description
S88-32	51484U	ELECTRODE KIT for Beckett AF II, HLX (up to 9" air tube)
		2 - Electrode assemblies 2 - Extension rods with nuts
S88-34	51670U	ELECTRODE KIT for Beckett AF II, FBX (up to 9" air tube)
		2 - Electrode assemblies 2 - Extension rods with nuts
S88-36	BK-1	ELECTRODE KIT for Beckett AF, AR, SF, SR (up to 9" air tube)
		2 - Beckett 1510 electrodes 2 - 3/16" x 6" buss bar rods
S88-38	BK-2	ELECTRODE KIT for Beckett AF, AR, SF, SR (all size air tube)
		2 - Beckett 1510 electrodes 2 - 3/16" x 13" buss bar rods
S88-50	CK 780	TUNE-UP KIT for Carlin Elite burner
		2 - Electrode assemblies 1 - 12" oil line assembly 1 - Red Tip setting gauge
S88-60	WMK-100	TUNE-UP KIT for Weil McLain burner
		1 - One piece electrode assembly 2 - Ignition cable leads
S88-70	31156	TUNE-UP KIT for Wayne ER, ERA, EH, EHA, EHASR, M, MSR, MH, OE, OEA
		2 - Electrode stems 2 - Electrode assemblies w/insul. 2 - Insulator bushings 2 - Buss bars (8") 1 - Buss bar support
S88-72	31156W	TUNE-UP KIT for Wayne ER, ERA, EH, EHA, EHASR, M, MSR, MH, OE, OEA
		Same components as S88-70, manufactured by Westwood
S88-74	31157	TUNE-UP KIT for Wayne Blue Angel model HS
		2 - Electrode assemblies w/buss bars 1 - Electrode support 1 - Buss bar support 1 - Oil line assembly
S88-76	31157W	TUNE-UP KIT for Wayne Blue Angel model HS
		Same components as S88-74, manufactured by Westwood

Packaging may vary from that shown

BLOWER WHEELS



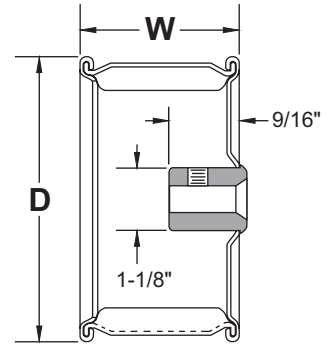

Westwood
BLOWER WHEELS

Precision balanced general purpose blower wheel ideal for oil burners. Blade strip is continuous and roll-locked front and back.



BLOWER WHEELS (Rotation as viewed from closed end)



CW		CCW		D	W	Fits shaft size	Comments
 No.	Ref. No.	 No.	Ref. No.				
STANDARD							
S90-10	4030	-	-	4"	3"	1/2"	
S90-12	4230	-	-	4-1/4"	3"	1/2"	
S90-14	4235	-	-	4-1/4"	3-1/2"	1/2"	
S90-16	4725	-	-	4-3/4"	2-1/2"	1/2"	
S90-18	4729	S91-18	4729-1	4-3/4"	3"	1/2"	
S90-20	4734	S91-20	4734-1	4-3/4"	3-1/2"	1/2"	
S90-22	5220	S91-22	5220-1	5-1/4"	2"	1/2"	
S90-24	5225	S91-24	5225-1	5-1/4"	2-1/2"	1/2"	
S90-26	5229	S91-26	5229-1	5-1/4"	3"	1/2"	
S90-28	5234	S91-28	5234-1	5-1/4"	3-1/2"	1/2"	
S90-30	5729	S91-30	5729-1	5-3/4"	3"	1/2"	
S90-32	5734	S91-32	5734-1	5-3/4"	3-1/2"	1/2"	
S90-34	5738	S91-34	5738-1	5-3/4"	3-7/8"	1/2"	
S90-36	6325	-	-	6-1/4"	2-1/2"	1/2"	
S90-38	6329	S91-38	6329-1	6-1/4"	3"	1/2"	
S90-40	6334	S91-40	6334-1	6-1/4"	3-1/2"	1/2"	
S90-42	6338	S91-42	6338-1	6-1/4"	3-7/8"	1/2"	
S90-44	6342	S91-44	6342-1	6-1/4"	4-1/4"	1/2"	
S90-46	6346	-	-	6-1/4"	4-5/8"	1/2"	
-	-	S91-48	7243-1	7-1/4"	4-3/8"	1/2"	
SPECIAL							
S90-60	475-243	-	-	4-3/4"	2-7/16"	1/2"	Outside hub
S90-62	475-287	-	-	4-3/4"	2-7/8"	1/2"	Lovejoy prongs
S90-64	575-287	-	-	5-3/4"	2-7/8"	1/2"	Lovejoy prongs
S90-66	625-400	-	-	6-1/4"	4"	1"	Cast hub
S90-68	951-78	-	-	7"	4"	1"	Heavy braces
S90-70	951-81	-	-	9-3/16"	5"	5/8"	Heavy braces
-	-	S91-72	951-170	9-3/16"	5"	7/8"	Heavy braces
-	-	S91-74	951-57	11-3/4"	6"	1-1/8"	Heavy braces

Please order by  No.

GAUGES



PRESSURE GAUGES



 No.	Ref. No.	Mount	Face	Range	 No.	Ref. No.	Mount	Face	Range
S100-100	146010	1/8" CBM	1-1/2"	0-15 PSI	S100-142	47738	1/4" LM	2-1/2"	0-30 PSI
S100-102	146011	1/8" CBM	1-1/2"	0-30 PSI	S100-144	47495	1/4" LM	2-1/2"	0-60 PSI
S100-104	146013	1/8" CBM	1-1/2"	0-100 PSI	S100-146	45331	1/4" LM	2-1/2"	0-100 PSI
S100-106	49488	1/4" CBM	2"	0-30 PSI	S100-148	48365	1/4" LM	2-1/2"	0-160 PSI
S100-108	47615	1/4" LM	2"	0-15 PSI	S100-150	46913	1/4" LM	2-1/2"	0-200 PSI
S100-110	46644	1/4" LM	2"	0-30 PSI	S100-152	45765	1/4" LM	2-1/2"	0-300 PSI
S100-112	45764	1/4" LM	2"	0-60 PSI	S100-154	49611	1/4" LM	2-1/2"	0-400 PSI
S100-114	45330	1/4" LM	2"	0-100 PSI	S100-156	46648	1/4" LM	2-1/2"	0-600 PSI
S100-116	46912	1/4" LM	2"	0-160 PSI	S100-158	5504	1/4" LM	3-1/2"	0-30 PSI
S100-118	47101	1/4" LM	2"	0-200 PSI	S100-160	5506	1/4" LM	3-1/2"	0-60 PSI
S100-120	46778	1/4" LM	2"	0-300 PSI	S100-162	5508	1/4" LM	3-1/2"	0-100 PSI
S100-122	47492	1/4" LM	2"	0-400 PSI	S100-164	5510	1/4" LM	3-1/2"	0-160 PSI
S100-124	47493	1/4" LM	2"	0-600 PSI	S100-166	5512	1/4" LM	3-1/2"	0-200 PSI
S100-126	52420	1/8" LM	2"	0-15 PSI	S100-168	5514	1/4" LM	3-1/2"	0-300 PSI
S100-128	47490	1/8" LM	2"	0-30 PSI	S100-170	5515	1/4" LM	3-1/2"	0-400 PSI
S100-130	52576	1/8" LM	2"	0-60 PSI	S100-172	5516	1/4" LM	3-1/2"	0-600 PSI
S100-132	47491	1/8" LM	2"	0-100 PSI	S100-174	5551	1/4" LM	4-1/2"	0-60 PSI
S100-134	48302	1/8" LM	2"	0-160 PSI	S100-176	5554	1/4" LM	4-1/2"	0-100 PSI
S100-136	46645	1/8" LM	2"	0-200 PSI	S100-178	5561	1/4" LM	4-1/2"	0-200 PSI
S100-138	48363	1/8" LM	2"	0-300 PSI	S100-180	5563	1/4" LM	4-1/2"	0-300 PSI
S100-140	47102	1/4" LM	2-1/2"	0-15 PSI					

PRESSURE GAUGES - LIQUID FILLED - Stainless steel case





 No.	Ref. No.	Mount	Face	Range	 No.	Ref. No.	Mount	Face	Range
S100-200	166664	1/8" CBM	1-1/2"	0-30 PSI	S100-238	165295	1/4" CBM	2"	0-1000 PSI
S100-202	166665	1/8" CBM	1-1/2"	0-60 PSI	S100-240	165296	1/4" LM	2-1/2"	0-30 PSI
S100-204	166666	1/8" CBM	1-1/2"	0-100 PSI	S100-242	165297	1/4" LM	2-1/2"	0-60 PSI
S100-206	166667	1/8" CBM	1-1/2"	0-160 PSI	S100-244	165298	1/4" LM	2-1/2"	0-100 PSI
S100-208	166668	1/8" CBM	1-1/2"	0-300 PSI	S100-246	165299	1/4" LM	2-1/2"	0-160 PSI
S100-210	166669	1/8" CBM	1-1/2"	0-1000 PSI	S100-248	165300	1/4" LM	2-1/2"	0-300 PSI
S100-212	165282	1/4" LM	2"	0-30 PSI	S100-250	165301	1/4" LM	2-1/2"	0-600 PSI
S100-214	165283	1/4" LM	2"	0-60 PSI	S100-252	165302	1/4" LM	2-1/2"	0-1000 PSI
S100-216	165284	1/4" LM	2"	0-100 PSI	S100-254	165377	1/4" LM	2-1/2"	0-2000 PSI
S100-218	165285	1/4" LM	2"	0-160 PSI	S100-256	165378	1/4" LM	2-1/2"	0-3000 PSI
S100-220	165286	1/4" LM	2"	0-300 PSI	S100-258	165303	1/4" CBM	2-1/2"	0-30 PSI
S100-222	165287	1/4" LM	2"	0-600 PSI	S100-260	165304	1/4" CBM	2-1/2"	0-60 PSI
S100-224	165288	1/4" LM	2"	0-1000 PSI	S100-262	165305	1/4" CBM	2-1/2"	0-100 PSI
S100-226	165289	1/4" CBM	2"	0-30 PSI	S100-264	165306	1/4" CBM	2-1/2"	0-160 PSI
S100-228	165290	1/4" CBM	2"	0-60 PSI	S100-266	165307	1/4" CBM	2-1/2"	0-300 PSI
S100-230	165291	1/4" CBM	2"	0-100 PSI	S100-268	165308	1/4" CBM	2-1/2"	0-600 PSI
S100-232	165292	1/4" CBM	2"	0-160 PSI	S100-270	165309	1/4" CBM	2-1/2"	0-1000 PSI
S100-234	165293	1/4" CBM	2"	0-300 PSI	S100-272	165380	1/4" CBM	2-1/2"	0-2000 PSI
S100-236	165294	1/4" CBM	2"	0-600 PSI	S100-274	165381	1/4" CBM	2-1/2"	0-3000 PSI

1/4" = 1/4" NPT pipe thread
1/8" = 1/8" NPT pipe thread

CBM = Center back mount
LM = Low mount
LBM = Low back mount



Please order by  No.

LOW PRESSURE DIAPHRAGM GAUGES

 No.	Ref. No.	Mount	Face	Range	 No.	Ref. No.	Mount	Face	Range
S100-300	161963	1/4" LM	2-1/2"	15" WC	S100-318	161971	1/4" LM	2-1/2"	10 PSI
S100-302	161964	1/4" LM	2-1/2"	35" WC	S100-320	161972	1/4" LM	2-1/2"	20 oz.-35" WC
S100-304	162787	1/4" LM	2-1/2"	60" WC	S100-322	21551	1/4" CBM	2-1/2"	15" WC
S100-306	161965	1/4" LM	2-1/2"	100" WC	S100-324	21552	1/4" CBM	2-1/2"	35" WC
S100-308	161966	1/4" LM	2-1/2"	200" WC	S100-326	75995	1/4" CBM	2-1/2"	60" WC
S100-310	161967	1/4" LM	2-1/2"	20 oz.	S100-328	75991	1/4" CBM	2-1/2"	20 oz.
S100-312	161968	1/4" LM	2-1/2"	32 oz.	S100-330	21553	1/4" CBM	2-1/2"	36 oz.
S100-314	161969	1/4" LM	2-1/2"	36 oz.	S100-332	21554	1/4" CBM	2-1/2"	5 PSI
S100-316	161970	1/4" LM	2-1/2"	5 PSI	S100-334	75996	1/4" CBM	2-1/2"	10 PSI



COMPOUND GAUGES

 No.	Ref. No.	Mount	Face	Range	 No.	Ref. No.	Mount	Face	Range
S100-400	47925	1/8" LM	2"	30"-60 PSI	S100-408	46646	1/4" LM	2-1/2"	30"-60 PSI
S100-402	49609	1/8" LM	2"	30"-150 PSI	S100-410	47411	1/4" LM	2-1/2"	30"-150 PSI
S100-404	75260	1/8" LM	2"	30"-300 PSI	S100-412	58156	1/4" LM	2-1/2"	30"-300 PSI
S100-406	47105	1/4" LM	2-1/2"	30"-30 PSI					



GAUGE ADAPTER

 No.	Description
S100-10	1/4"-NPT (F) x 1/8"-NPT (M) Brass gauge adapter

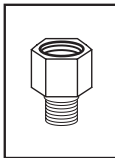

VACUUM GAUGES

 No.	Ref. No.	Mount	Face	Range
S100-500	47225	1/8" LM	2"	0 - 30" Hg
S100-502	47103	1/4" LM	2"	0 - 30" Hg
S100-504	47104	1/4" LM	2-1/2"	0 - 30" Hg



TEST GAUGES

 No.	Ref. No.	Type	Mount	Face	Range	Refrigerant Scale	For Westwood Tester
S100-280	-	Pressure*	1/8" LM	2"	0 - 300 PSI	-	T10
S100-285	-	Pressure*	1/8" LM	2-1/2"	0 - 300 PSI	-	T20
S100-290	-	Vacuum*	1/8" LM	2"	0 - 30" Hg	-	T15
S100-295	-	Vacuum*	1/8" LM	2-1/2"	0 - 30" Hg	-	T20
S100-600	169128	Refrigerant	1/8" LM	2-1/2"	30" Hg - 350 PSI	R-12, R-22, R-502	-
S100-610	169129	Refrigerant	1/8" LM	2-1/2"	0 - 500 PSI	R-12, R-22, R-502	-
S100-620	169130	Refrigerant	1/8" LM	2-1/2"	30" Hg - 350 PSI	R-134A	-
S100-630	169131	Refrigerant	1/8" LM	2-1/2"	0 - 500 PSI	R-134A	-
S100-640	169132	Refrigerant	1/8" LM	2-1/2"	30" Hg - 500 PSI	R-410A	-
S100-650	169133	Refrigerant	1/8" LM	2-1/2"	0 - 800 PSI	R-410A	-

* Liquid filled, stainless steel case



PRESSURE & VACUUM TESTERS starting on page T1

Please order by  No.

1/4" = 1/4"- NPT pipe thread
1/8" = 1/8"- NPT pipe thread

CBM = Center back mount
LM = Low mount
LBM = Low back mount

PUMP STRAINERS & GASKETS

Westwood
OIL BURNER PUMP STRAINERS & GASKETS
 STAINLESS STEEL MESH • NYLON ENDS • SONICALLY WELDED

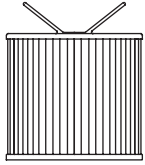
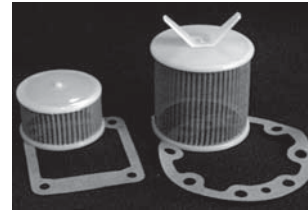

 No. **S150 (Series)**
 Suntec J, H, S



 No. **S160 (Series)**
 Suntec A70

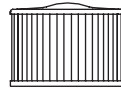

 No. **S170 (Series)**
 Suntec B80, 1-3/8"

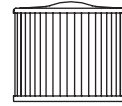

 No. **S180 (Series)**
 Suntec B80, 1-5/8"

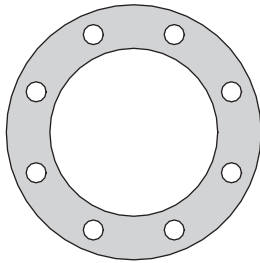

 No. **S150 (Series)**
 Suntec J, H, S

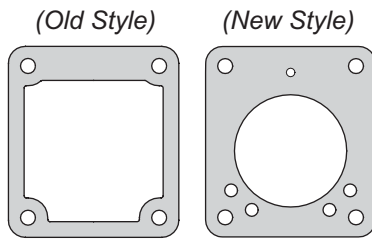

 No. **S190 (Series)**
 Suntec A70 & B80



 No. **S195**
 Riello



 No. **S197**
 Danfoss



 No. **S195-5**
 Riello



 No. **S197-5**
 Danfoss

 No.	Ref. No.	Description
S150	JHS	Strainer for Suntec J, H, S, individually boxed w/gasket
S150-10	-	Strainer for Suntec J, H, S, individually bagged w/gasket
S150-12	-	"P" Strainer for Suntec J, H, S, high capacity (coarse mesh), individually bagged w/gasket
S150-55	-	Cover gasket for Suntec J, H, S, package of 10 gaskets
S150-60	-	Cover gasket for Suntec J, H, S, package of 50 gaskets
S150-65	-	Cover gasket for Suntec J, H, S, package of 100 gaskets
S160-10	-	Strainer for Suntec A70 single-stage mini pump, individually bagged w/old style gasket
S160-12	-	Strainer for Suntec A70 single-stage mini pump, individually bagged w/new style gasket
S170	-	Strainer for Suntec B80 two-stage mini pump, 1-3/8" long, indiv. boxed w/old style gasket
S170-1	-	Strainer for Suntec B80 two-stage mini pump, 1-3/8" long, indiv. boxed w/new style gasket
S180	-	Strainer for Suntec B80 two-stage mini pump, 1-5/8" long, indiv. boxed w/old style gasket
S180-1	-	Strainer for Suntec B80 two-stage mini pump, 1-5/8" long, indiv. boxed w/new style gasket
S190	-	Cover gasket for Suntec A70 and B80 mini pumps, old style, package of 50 gaskets
S190-1	-	Cover gasket for Suntec A70 and B80 mini pumps, old style, package of 100 gaskets
S190-2	-	Cover gasket for Suntec A70 and B80 mini pumps, old style, package of 10 gaskets
S190-5	-	Cover gasket for Suntec A70 and B80 mini pumps, new style, package of 50 gaskets
S190-6	-	Cover gasket for Suntec A70 and B80 mini pumps, new style, package of 100 gaskets
S190-7	-	Cover gasket for Suntec A70 and B80 mini pumps, new style, package of 10 gaskets
S195	-	Strainer for Riello pump, individually bagged w/'O' ring gasket
S195-5	-	Cover 'O' ring gasket for Riello pump, package of 6 'O' rings
S197	-	Strainer for Danfoss pump, individually bagged w/'O' ring gasket
S197-5	-	Cover 'O' ring gasket for Danfoss pump, package of 6 'O' rings

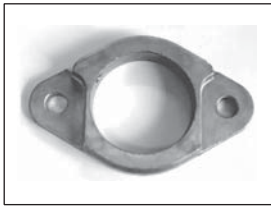

No. S200

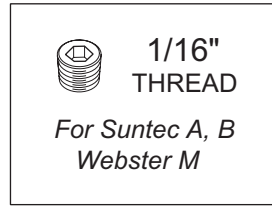

No. S211, -1

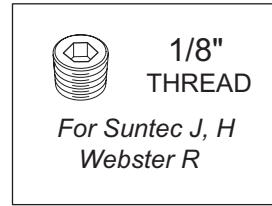

No. S211-2, -3

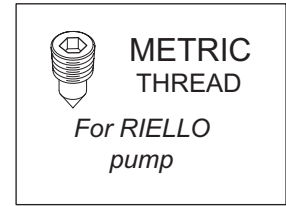

No. S211-4, -5

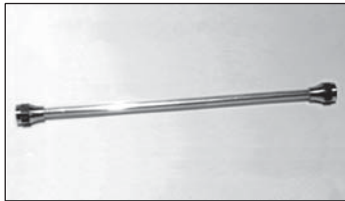

No. S213 & S214 (Series)

MILLER FURNACE OIL LINE KIT

- 1 - S213-7 oil line. For Wayne Home Equip. OE, OE-LS, M-LS, MSRH, Nu-Way FM, FM-LS, FS-LS, Beckett AF-15, when burner does not have a Sundstrand A1VA 17J1600 pump.
- 1 - S213-11 oil line. For Wayne Home Equip. OE, OE-LS, Nu-Way FM, FM-LS, when burner has Sundstrand A1VA 17J1600 pump.
- 1 - 1/4" flare x 3/16" flare reducer adapter for certain Wayne OE & OE-LS burners
- 1 - 3/16" flare x 1/8" NPT elbow for certain Wayne OE & OE-LS burners

No. S214-25

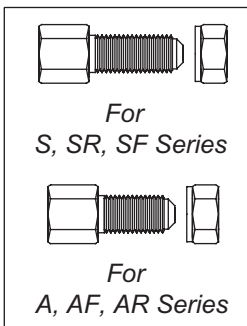

For
S, SR, SF Series

For
A, AF, AR Series

No. S215, -1

MAGIC*PATCH™
FOR TEMPORARY USE ON LEAKING FUEL OIL TANKS

TAKE THE **MAGIC*PATCH™** CHALLENGE

PUT A MAGIC*PATCH AGAINST A REGULAR MAGNETIC PATCH (PAD TO PAD, HELD TOGETHER BY THE MAGNETS) AND LEAVE THEM FOR 24 HOURS. AFTER THAT TIME TEST THE MAGNETS. YOU'LL SEE WHAT MAKES THE MAGIC*PATCH, "MAGIC"

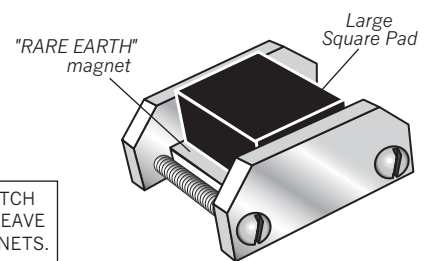

...holds like magic!

No. S216

PUMP FLANGE, BY-PASS PLUGS, OIL LINES & FITTINGS, MAGIC-PATCH

No.	Ref. No.	Description
S200	1194	Two hole pump flange w/set screws
S211	-	By-Pass Plug for Suntec A, B and Webster M, 1/16"- NPT, package of 10
S211-1	-	By-Pass Plug for Suntec A, B and Webster M, 1/16"- NPT, package of 100
S211-2	-	By-Pass Plug for Suntec J, H and Webster R, 1/8" NPT, package of 10
S211-3	-	By-Pass Plug for Suntec J, H and Webster R, 1/8" NPT, package of 100
S211-4	-	By-Pass Plug for RIELLO pump, (takes 2.5mm hex key), package of 10
S211-5	-	By-Pass Plug for RIELLO pump, (takes 2.5mm hex key), package of 100
S213-5	3605	Nozzle line w/flare nuts, 3/16" O.D. copper tubing, 5" long
S213-7	3607	Nozzle line w/flare nuts, 3/16" O.D. copper tubing, 7" long
S213-8	3608	Nozzle line w/flare nuts, 3/16" O.D. copper tubing, 8" long
S213-11	3611	Nozzle line w/flare nuts, 3/16" O.D. copper tubing, 11" long
S213-12	3612	Nozzle line w/flare nuts, 3/16" O.D. copper tubing, 12" long
S213-16	3616	Nozzle line w/flare nuts, 3/16" O.D. copper tubing, 16" long
S214-12	1412	Nozzle line w/flare nuts, 1/4" O.D. copper tubing, 12" long
S214-16	1416	Nozzle line w/flare nuts, 1/4" O.D. copper tubing, 16" long
S214-25	OL-711	Oil line parts kit for Miller furnaces, (1) S213-7, (1) S213-11, (2) fittings
S215	-	Replacement nozzle line fitting for Beckett S, SR, SF series burners
S215-1	-	Replacement nozzle line fitting for Beckett A, AF, AR series burners
S216	-	MAGIC*PATCH magnetic emergency tank leak patch

TIGERLOOP



The New **Tigerloop[®]**

World's most advanced oil de-aerator
...and the only one that's UL approved!



S14

rev. 5-1-05

Please order by  No.

The New Tigerloop®

Dual chamber design for better performance and safety

33% higher
de-aeration capacity



Protective vent shield

Patented anti-foam system

Universal mounting bracket

World's most advanced oil de-aerator!

After years of development, the next generation Tigerloop oil de-aerator has arrived! With over 30 years experience and more than 3.5 million Tigerloops installed worldwide, Tigerholm is uniquely qualified to take oil de-aeration to the next level.

More than just a problem solver!

For years, Tigerloop has been primarily thought of as a problem solver, a "band-aid," used to easily cure air and suction line problems. But, that's only part of the story! All systems benefit from Tigerloop's unique ability to condition the oil prior to burning. Whether it's air elimination, nozzle coking problems, vacuum reduction, oil preheating, or just the elimination of that potentially leaky return line, Tigerloop is today's safe, economical, environmentally friendly choice for all oil supply systems.

The Advantages of Tigerloop...

- Safely Handles suction line air leaks*
- Removes air entrained in oil during transporting and delivery*
- Reduces running vacuum for clear, foam-free oil at the nozzle*
- Eliminates potential leak hazard by eliminating the return line*
- Preheats the oil for cleaner combustion*
- Extends filter element life*

Technical Information

- Max. nozzle capacity: 20 gph
- Max. return oil pumped into the Tigerloop: 30 gph
- Max. oil flow: 50 gph
- Max. operating temperature: 105° F (40° C)
- Max. ambient temperature: 105° F (40° C)
- Max. operating pressure in feed line: 8 PSI
- Connections 1/4"-NPT (female)

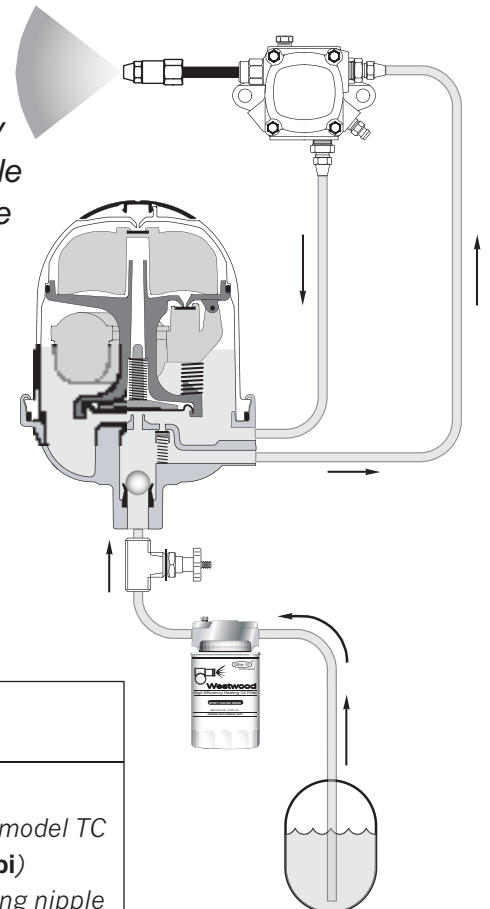

TIGERLOOP OIL DE-AERATOR

 No.	Description
S220	Tigerloop™ oil de-aerator, model TN, UL Listed
S220-4	Tigerloop™ Combi , combination oil de-aerator and filter, model TC
S220-6	Replacement filter element for S220-4 (Tigerloop™ Combi)
S220-10	3/8"- NPT Fiomatic valve w/3/8"-NPT x 1/4"-NPT reducing nipple

Please order by  No.

FLEXIBLE OIL LINES

GENUINE

Tigerloop

FLEXIBLE OIL LINES

Steel Braided Covering
 24" & 36" Long
 145 PSI - 200 °F
 Color coded Gold & Black
 for easy identification



For swing-out doors and oil de-aerators

FLEXIBLE OIL LINES, Standard

 No.	Description
S220-24	Flexible oil line, braided steel outside covering, 1/4"- NPT (MxM), 24" long
S220-36	Flexible oil line, braided steel outside covering, 1/4"- NPT (MxM), 36" long
S220-40	Replacement fitting for flexible oil line, 3/8" inv. flare x 1/4"-NPT

New!



Steel Braided Covering
 24" & 36" Long
 145 PSI - 200 °F
 Color coded Red & Blue
 for easy identification

FLEXIBLE OIL LINES

SPECIAL FOR RIELLO

Saves time & fittings!

European thread connects directly to **RIELLO** pump adaptor



PUMP END

Two piece swivel connector for easy installation and service



OTHER END

FLEXIBLE OIL LINES, Special for RIELLO burners

 No.	Description
S221-24	Flexible oil line, braided steel outside covering, 1/4"- NPT (M) x RIELLO pump adapter thread, 24" long
S221-36	Flexible oil line, braided steel outside covering, 1/4"- NPT (M) x RIELLO pump adapter thread, 36" long

E-Z Connect ADAPTOR FITTING

One fitting quickly connects the 1/4"-NPT male end of flexible oil lines to 3/8" FLARE!

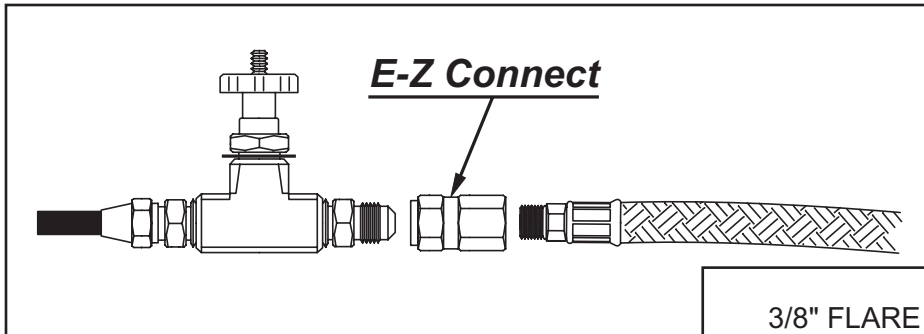

 No. S220-50

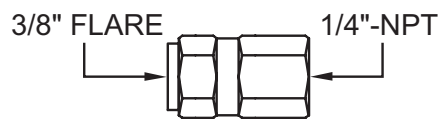

No more searching for fittings to improvise a connection!



OIL LINE SAFETY VALVE

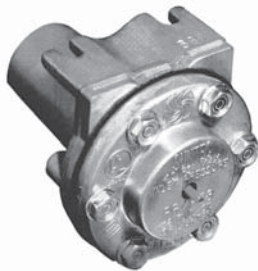

PRV Oil Line Safety Valve

Isolates burner components from fuel supply line pressure. Requires pump vacuum to draw oil from tank.

3/8" - NPT

 No. S225

CHECK VALVES

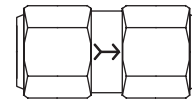

3/8" & 1/2" - NPT

 No. S230, -1

FLEXIBLE OIL LINE FITTING, SAFETY & CHECK VALVES

 No.	Description
S220-50	E-Z Connect brass adaptor fitting for connecting 3/8" flare to flexible oil lines
S225	Oil Line Safety Valve, Suntec PRV, 3/8"- NPT
S230	Check Valve for use in oil systems and P/V hand pumps, brass, soft seat, spring loaded, 3/8"-NPT
S230-1	Check Valve for use in oil systems and P/V hand pumps, brass, soft seat, spring loaded, 1/2"-NPT

END CONES & DRAFT REGULATOR

Westwood
END CONES

Heavy Duty Cast Iron

 No.	Ref. No.	A	B	C	Comment
S280	3200	3-1/2"	2-5/8"	5/8"	Northeast
S280-1	3201	3-7/8"	2-15/16"	5/8"	Paragon
S280-2	3202	4"	2"	1-3/16"	Texaco
S280-3	3203	4"	2-1/4"	1-5/16"	York
S280-4	3204	4"	2-1/4"	9/16"	York (short)
S280-5	3205	4"	2-3/8"	15/16"	Eddington
S280-6	3206	4-1/4"	3"	11/16"	-
S280-7	3207	5"	3-3/4"	9/16"	-

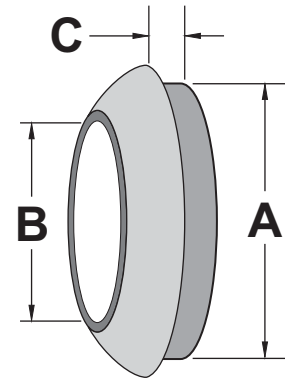

Westwood
UNIVERSAL DRAFT REGULATOR

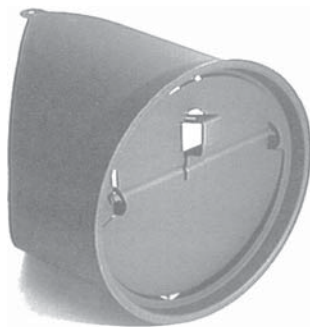

Combination 3 in 1 design fits the three most popular smoke pipe sizes.

6" - 7" - 8"

Reduces inventory, easy to adjust.

 No.	Ref. No.	Description
S300-300	#678	3 in 1 combination draft regulator, fits 6", 7", 8" smoke pipe

Westwood

CRANK ARMS - SWIVELS - PUSH RODS

PRECISION MACHINED • HEAVY DUTY • PLATED STEEL

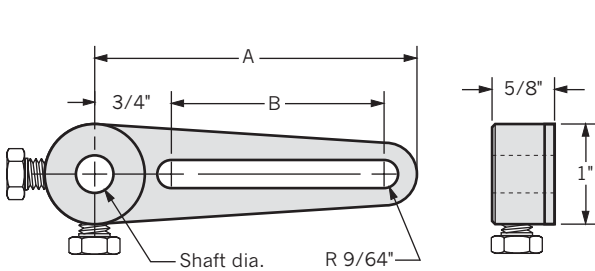

Slotted Crank Arm

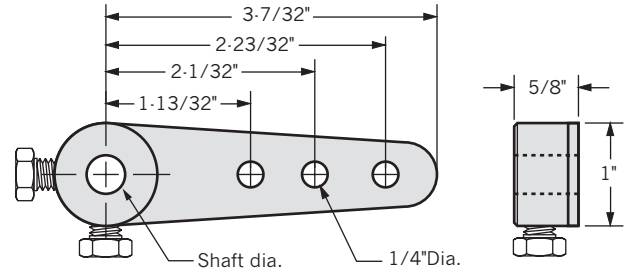

3 Hole Crank Arm

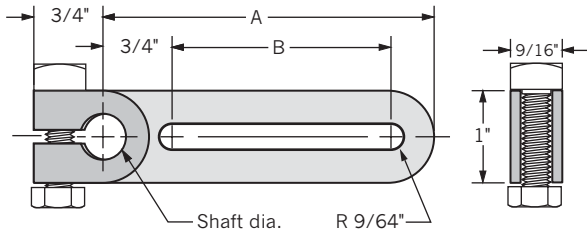

Slotted Crank Arm
(shaft clamping)

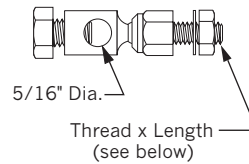

Swivel

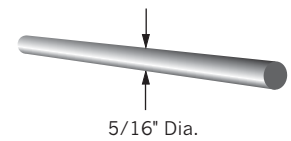

Push Rod

 No.	Ref. No.	Shaft Dia.	A	B	Swivel Thread x Length	Push Rod Length	Description
S300-400	ARM-3S	3/8"	3-3/16"	2-1/8"	-	-	Slotted crank arm
S300-402	ARM-5S	1/2"	3-3/16"	2-1/8"	-	-	Slotted crank arm
S300-404	ARM-3L	3/8"	4-15/16"	3-7/8"	-	-	Slotted crank arm
S300-406	ARM-5L	1/2"	4-15/16"	3-7/8"	-	-	Slotted crank arm
S300-408	ARM-14	3/8"	-	-	-	-	3 hole crank arm
S300-410	ARM-15	1/2"	-	-	-	-	3 hole crank arm
S300-412	ARM-5C	1/2"	3-19/32"	2-3/8"	-	-	Clamping crank arm
S300-414	SW-4	-	-	-	1/4-20 x 7/16"	-	Swivel
S300-416	SW-5	-	-	-	5/16-24 x 41/64"	-	Swivel
S300-418	SW-6	-	-	-	5/16-24 x 33/64"	-	Swivel
S300-420	SW-8	-	-	-	1/4-28 x 9/16"	-	Swivel
S300-422	SW-9	-	-	-	1/4-20 x 9/16"	-	Swivel
S300-424	PR-12	-	-	-	-	12"	5/16" dia. push rod
S300-426	PR-18	-	-	-	-	18"	5/16" dia. push rod
S300-428	PR-24	-	-	-	-	24"	5/16" dia. push rod
S300-430	PR-36	-	-	-	-	36"	5/16" dia. push rod
S300-432	PR-48	-	-	-	-	48"	5/16" dia. push rod

OBSERVATION PORTS & SIGHT GLASSES

Westwood

HIGH TEMPERATURE GLASSWARE

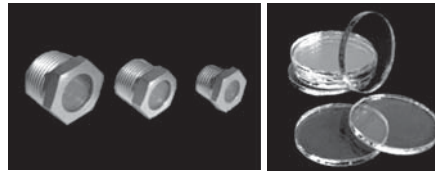

BOROSILICATE GLASS • 600° - 800°F SERVICE



OBSERVATION PORTS - Clear, Male Pipe Thread Mount

 No.	Reference No.	Pipe Thread	Working Pressure
S305-37	OBS-38	3/8"- NPT	3,700 PSI
S305-50	OBS-50	1/2"- NPT	3,500 PSI
S305-75	OBS-75	3/4"- NPT	3,000 PSI
S305-100	OBS-100	1"- NPT	2,500 PSI
S305-125	OBS-125	1-1/4"- NPT	2,000 PSI
S305-150	OBS-153	1-1/2"- NPT	1,500 PSI

ROUND SIGHT GLASSES - Clear

Diameter	 No.			Diameter	 No.		
	1/8" Thick	3/16" Thick	1/4" Thick		1/8" Thick	3/16" Thick	1/4" Thick
1"	S312-100	S318-100	S325-100	2-5/8"	S312-262	S318-262	S325-262
1-1/8"	S312-112	S318-112	S325-112	2-3/4"	S312-275	S318-275	S325-275
1-3/16"	S312-118	S318-118	S325-118	3"	S312-300	S318-300	S325-300
1-1/4"	S312-125	S318-125	S325-125	3-1/8"	S312-312	S318-312	S325-312
1-3/8"	S312-137	S318-137	S325-137	3-3/16"	S312-318	S318-318	S325-318
1-7/16"	S312-143	S318-143	S325-143	3-1/4"	S312-325	S318-325	S325-325
1-1/2"	S312-150	S318-150	S325-150	3-3/8"	S312-337	S318-337	S325-337
1-5/8"	S312-162	S318-162	S325-162	3-7/16"	S312-343	S318-343	S325-343
1-3/4"	S312-175	S318-175	S325-175	3-1/2"	S312-350	S318-350	S325-350
2"	S312-200	S318-200	S325-200	3-5/8"	S312-362	S318-362	S325-362
2-1/8"	S312-212	S318-212	S325-212	3-3/4"	S312-375	S318-375	S325-375
2-3/16"	S312-218	S318-218	S325-218	4"	S312-400	S318-400	S325-400
2-1/4"	S312-225	S318-225	S325-225	4-1/2"	S312-450	S318-450	S325-450
2-3/8"	S312-237	S318-237	S325-237	5"	S312-500	S318-500	S325-500
2-7/16"	S312-243	S318-243	S325-243	6"	S312-600	S318-600	S325-600
2-1/2"	S312-250	S318-250	S325-250				

Special size round, square, rectangular shapes, and colors available. Consult the factory for price and delivery.

BOILER & FURNACE CLEANING ITEMS

"SERVICE-SAW" BOILER SCALE BUSTING TOOL



Length: 32 in.

No. S400

"SOOT SABER" BOILER CLEANING TOOLS

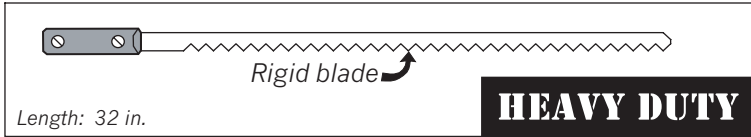

Length: 32 in.

No. S402

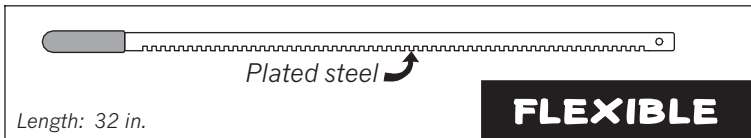

Length: 32 in.

No. S405

"SOOT SNAKE" VAC HOSE

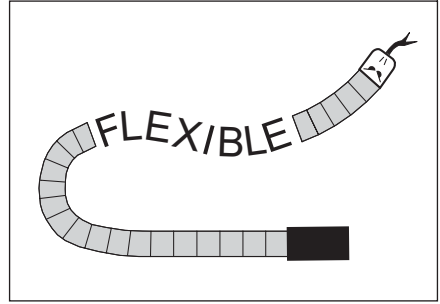

No. S410

SOOT SHOVEL

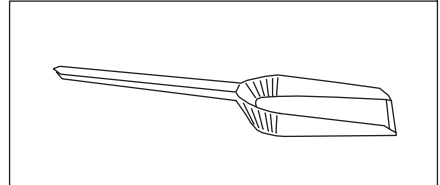

No. S412

VACUUM CLEANER BAGS - Wrap around seam sealed for strength

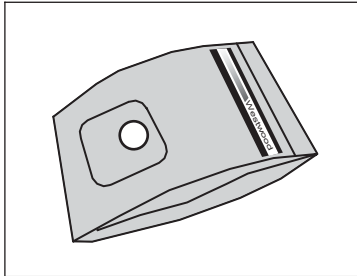

No. S450-14, -15

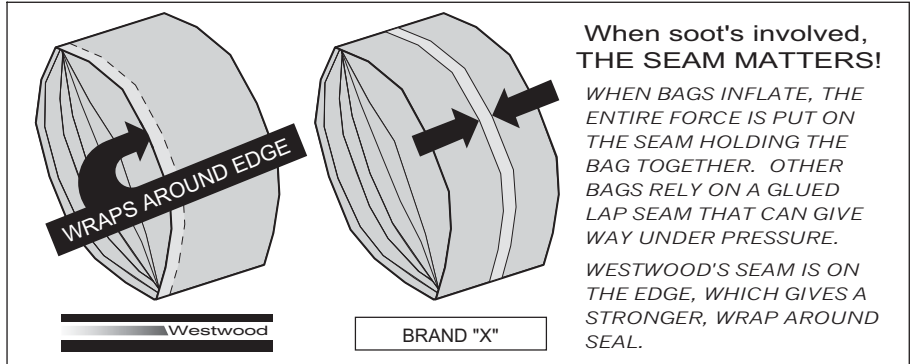

CLEANING TOOLS & VACUUM CLEANER BAGS

No.	Reference No.	Description
S400	Service-Saw	"Service-Saw" boiler scale cleaning tool, tempered steel saw blade, plastic handle
S402	-	"SOOT SABER" Heavy Duty (rigid) boiler cleaning tool, zinc coated steel, wood handle
S405	-	"SOOT SABER" Flexible boiler cleaning tool, zinc coated steel, soft vinyl handle
S410	-	"SOOT SNAKE" Flexible steel vacuum cleaner hose, 7/8" dia., 48" long, with installed rubber adapter to fit a standard 1-1/2" rubber vacuum cleaner hose
S412	-	Soot Shovel, 4-1/2" wide, 19-1/2" long, steel with black enamel finish
S450-14	-	Style 4464 (3-1/2 gal.) vacuum cleaner bags. Fits Mastercraft 605, 641, 1100, 6500 and others; Sid Harvey S12. Package of 5 bags
S450-15	-	Style 4465 (5 gal.) vacuum cleaner bags. Fits Mastercraft 652, 653, 880, 990, 1005, 1010, 1015, 1200, 7000, 13008, D6508, D6520, D6530, W6508, W6509, W6510, 6513, and others; Sid Harvey S14. Package of 5 bags

Please order by No.

SAFETY & SPILL CLEANUP**Safety and Spill Cleanup Supplies**

Good service practice not only considers the safety of the service tech, but also requires preparedness for those emergency situations that can happen when least expected. These products belong in every service organization.

 No.	Sold by	Description
S500	Pair	Brown jersey gloves, man's hand size
S500-2	Pair	White cotton canvas gloves, man's hand size
S500-4	Box of 100	Nitrile oil resistant gloves, size LARGE
S500-6	Box of 100	Nitrile oil resistant gloves, size X-LARGE
S500-8*	Pair	Nitrile oil resistant reusable gloves
S500-10	Each	Disposable dust mask, elastic strap, not rated
S500-12	Each	Disposable dust mask, elastic strap, N95 rated
S500-14	Each	Adjustable plastic safety glasses, clear lenses
S500-16	Each	Adjustable plastic safety glasses, smoked lenses
S500-18*	Each	Plastic splash goggles, elastic strap
S500-20	Pair	Non-woven fabric slip-on shoe covers
S500-22*	Package of 20	7 bu. plastic (3 mil.) contractor disposal bags
S500-24	Box	Polo rags (mixed colors), 5 lb. box
S500-26	Package of 100	Flat paper wipes, 13" x 13"
S500-28*	Package of 100	Universal absorbent pads (for all liquids), 17" x 18" x 1/8" thick
S500-30*	Package of 100	Oil only absorbent pads, 16-1/2" x 19-1/2" x 3/16" thick
S500-32*	Package of 40	Universal absorbent socks (for all liquids), 3" dia. x 48" long
S500-34*	Package of 40	Oil only absorbent socks, 3" dia. x 48" long
S500-36	Each	Large non-woven fabric drop cloth, water repellent, 6' x 9'
S500-38	Each	Economy Spill Kit in heavy duty zippered carrying bag Contains: 1 - splash goggles 1 - pair nitrile reusable gloves 2 - contractor bags 1 - Universal absorbent sock 1 - Oil only absorbent sock 5 - Universal absorbent pads 5 - Oil only absorbent pads 1 - Heavy duty clear plastic zippered carrying bag

* Part of the S500-38 Economy Spill Kit (see listing above for quantities of each included in the kit).

Westwood

"PRESSURE-VIEW" OIL BURNER PUMP TESTER

- ▶ Quick-connect fittings require only finger tightening
- ▶ Brass construction with color coded hoses
- ▶ Fits popular 3/16" and 1/4" nozzle line fittings
- ▶ Stainless steel liquid filled gauge, range 0 - 300 PSI
- ▶ Easy-to-follow instructions - rugged carrying case



 No. T10

Precisely sets pump pressure and checks cut-off with accuracy not possible using non-liquid filled gauges. Gauge liquid dampens pulsation allowing precise measurement and protects gauge from hydraulic shock damage. Choose between pressure measurement and cut-off test with just the turn of the knob - no disconnecting! "Service Truck Tough" carrying case with complete instructions.

Westwood

"VACUUM-VIEW" SUCTION LINE ANALYZER

- ▶ Thick clear tubing does not collapse from vacuum
- ▶ All brass with stainless steel tubing clamps
- ▶ Fits popular 3/8" and 1/2" suction line fittings
- ▶ Stainless steel liquid filled gauge, range 0 - 30" Hg
- ▶ Easy-to-follow instructions - rugged carrying case

 No. T15

Analyze suction line problems (ie. air leaks, restrictions, dirt, etc.) using this clear tubing service tool. Vacuum gauge liquid dampens pulsation allowing precise measurement and protects gauge from hydraulic shock damage. Actually see what's happening inside that problem suction line! Complete instructions and "Service Truck Tough" carrying case.

OIL BURNER PUMP PRESSURE & VACUUM TESTERS

 No.	Description
T10	Complete oil burner pump tester w/case, quick-connect fittings and instructions
T10-3	Replacement adaptor fittings for T10 tester, 3/16" X 1/4" flare, Pkg. of 2
T10-4	Replacement rubber quick-connect seats (gaskets) for T10 tester, Pkg. of 12
T10-5	Replacement hose set (2 color coded hoses) for T10 tester
S100-280	Replacement Liquid Filled 0-300 PSI Pressure Gauge for T10 tester
T15	Complete suction line analyzer w/case, adaptor fittings and instructions
T15-1	Replacement adaptor fittings for T15 tester, 1/2" suction line, Pkg. of 2
T15-2	Replacement clear tubing w/clamps for T15 tester
S100-290	Replacement Liquid Filled 0-30" Hg. Vacuum Gauge for T15 tester

 Take a look ...

For testing RIELLO pumps see page T2

 Please order by  No.

RIELLO TESTERS

RIELLO PUMP TESTERS

The first tester specifically designed for the Riello pump! Quick-Connect European thread adaptors mount easily on the pump with just finger tightening. The 24" color coded flexible lines allow the tester to be placed in any convenient location for remote reading of the pump pressure and vacuum.

- ▶ Quick-connect European thread fittings require only finger tightening
- ▶ Liquid Filled gauges dampen pulsation - no hydraulic shock
- ▶ "Service Truck Tough" case

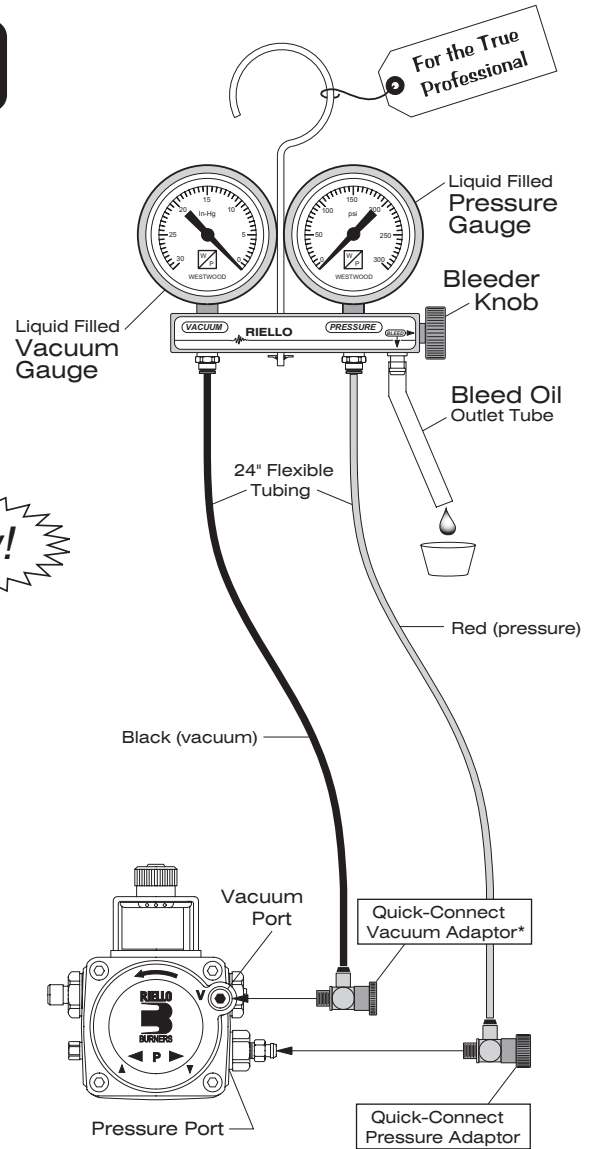
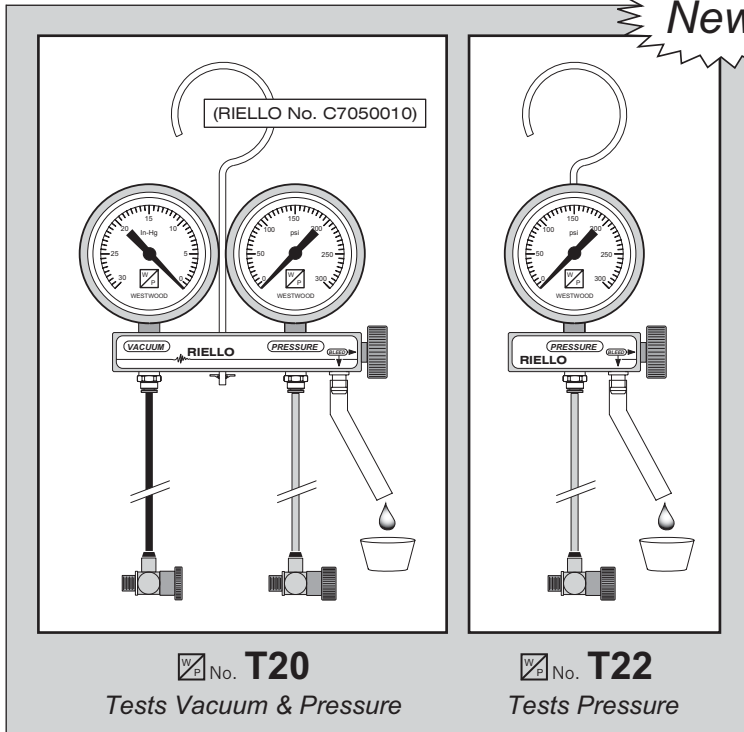

*Can also be used on older pumps that have the vacuum port on the side of the pump.

 No.	RIELLO No.	Description
T20	C7050010	Complete RIELLO tester with case, liquid filled gauges, Quick-Connect adaptor fittings
T20-10	-	Replacement hose set (1 ea. Red and Black) for T20 tester
T20-12	-	Replacement "O" ring for T20 and T22 tester Quick-Connect adaptors, Pkg. of 6
T20-14	-	Replacement Nylon washer for T20 and T22 tester Quick-Connect adaptors, Pkg. of 6
T20-16	-	Replacement "Drip Cap" for T20 and T22 tester Quick-Connect adaptors, Pkg. of 6
T20-18	-	Replacement carrying case for T20 tester
T22	-	RIELLO pressure tester with case, liquid filled gauge, Quick-Connect adaptor fitting
T22-10	-	Replacement hose (Red) for T22 tester
T22-18	-	Replacement carrying case for T22 tester
S100-285	-	Replacement Liquid Filled 0-300 PSI pressure gauge (2-1/2" face) for T20 and T22
S100-295	-	Replacement Liquid Filled 0-30" Hg. vacuum gauge (2-1/2" face) for T20

T2

rev. 5-1-05

 Take a look ...

For testing SUNTEC & WEBSTER pumps see page T1

Please order by  No.

VAC-PROBE & BLEED WRENCH

Westwood
"VAC-PROBE" OIL LINE ACCESS PORT

Allows access to oil lines without opening or disconnecting fittings. Installed in place of the center bolt on the line filter it allows not only vacuum tests to be made quickly and neatly, but also affords easy access to the fuel system for pump priming and connection of a temporary oil line (run outs). One piece solid steel construction.

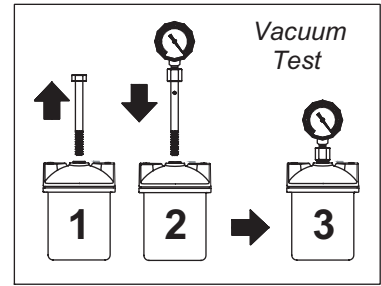

- ▶ Quickly and neatly access fuel system without disconnecting fittings!
- ▶ Liquid filled gauge dampens pulsation allowing precise measurement and protects gauge from hydraulic shock damage
- ▶ Models available for all popular heating oil line filters

 No.	Description
T25	Vac-Probe Kit; (1) Vacuum gauge, (4) Vac-Probes-1 ea.
T25-1	Vac-Probe w/gauge for small General 1A style filter
T25-2	Vac-Probe No. T25-1, less gauge
T25-3	Vac-Probe w/gauge for large General 2A style filter
T25-4	Vac-Probe No. T25-3, less gauge
T25-5	Vac-Probe w/gauge for Fulflo FB4, FB6, FB8, FB10
T25-6	Vac-Probe No. T25-5, less gauge
T25-7	Vac-Probe w/gauge for Firomatic C-40, C-50
T25-8	Vac-Probe No. T25-7, less gauge

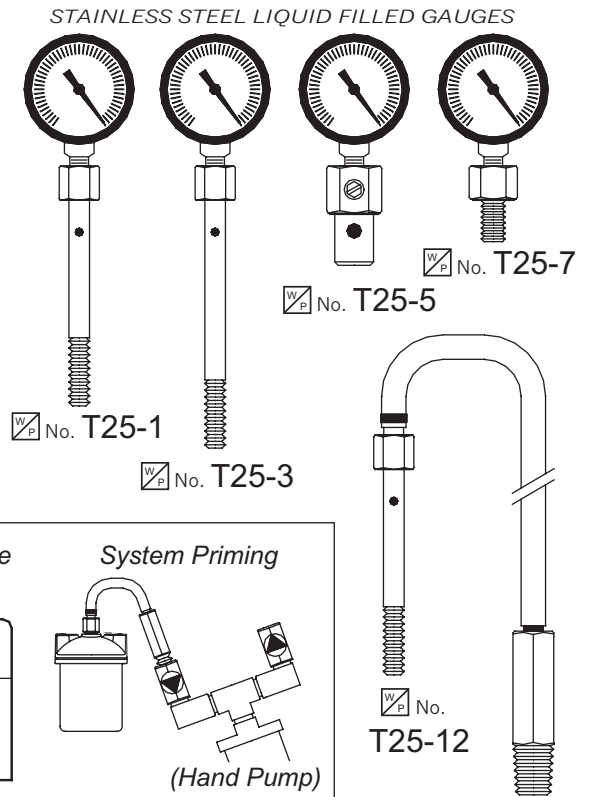

 No.	Vac-Probe Run Out Adaptor*
T25-12	For small General 1A style filter
T25-14	For large General 2A style filter
T25-16	For Fulflo FB4, FB6, FB8, FB10 filters
T25-18	For Firomatic C-40, C-50 filters

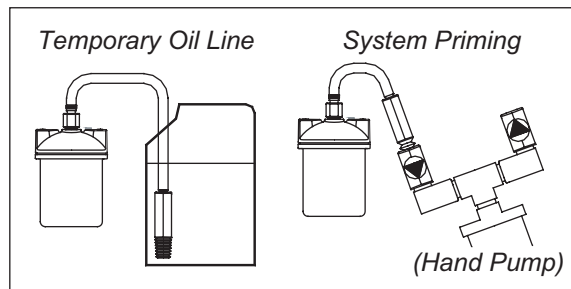



*Vac-Probe w/48" flexible hose connected to a heavy weight 3/8" NPT hand pump connection adaptor. Adaptor easily connects to a hand pump, or serves as a hose end weight when drawing oil from a can.

Westwood **"FLO-THRU"** *Sliding Handle* **BLEED WRENCH**

- ▶ Quickly and neatly bleed oil burner pumps
- ▶ Handle slides side-to-side for easy bleeding

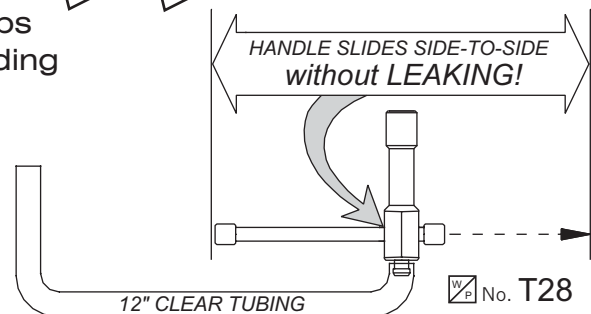
 No.	Description
T28	Bleed Wrench with 12" hose
T28-2	Replacement hose, Pkg. of 6



Please order by  No.

HAND PUMPS

Westwood

"EASY ANGLE" PRESSURE & VACUUM HAND PUMPS

Hand operated piston pumps with built-in check valves for use with liquids and air. Ideal for clearing plugged oil lines, priming pumps, transferring liquids, and adding chemicals to boilers. Heavy duty brass and steel construction.

- ▶ Unique "EASY ANGLE" 120° valve angle makes connections easy
- ▶ Two Sizes - Standard and High Capacity
- ▶ High Capacity model gives 50% more volume per stroke!
- ▶ Exclusive center port for installation of a compound gauge allows monitoring of the system pressure and vacuum during operation
- ▶ Comfortable "T" handle and protective vinyl sleeve on barrel
- ▶ Quick-connect hose set attaches to hand pump using no tools! (Same, no tools needed connection to all popular hand pumps)



 No. T30
STANDARD

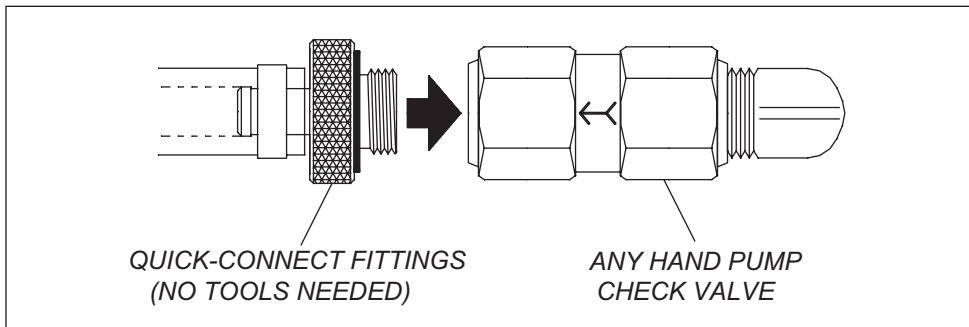

 No. T30-4

QUICK-CONNECT FITTINGS & HOSE SET

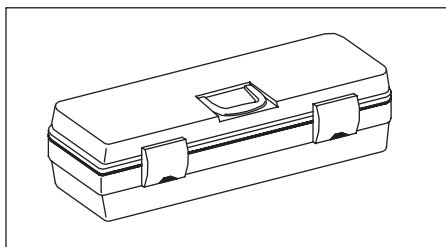

 No. T30-6

CARRYING CASE FOR T30 & T30-4



 No. S100-402

CENTER PORT COMPOUND GAUGE
30" Hg. - 150 PSI (2" FACE, 1/8"- NPT)









 No. T30-1

HIGH CAPACITY

 No.	Description
T30	Standard hand pump w/ 1/8"- NPT center access port
T30-1	High capacity hand pump w/ 1/8"- NPT center access port
T30-4	Quick-connect, no tools needed fittings and hoses set
T30-6	Plastic carrying case for T30 hand pump, fittings and hoses
T30-8	"O" ring for T30, -1 and all 1-1/4" barrel pumps, Pkg. of 2
S100-402	Compound pressure-vacuum gauge for center access port
S230	Replacement check valve, 3/8" NPT, soft seat, spring loaded

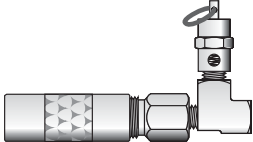
Westwood

CO₂ BLOW OUT GUNS & KITSFOR QUICKLY CLEARING PLUGGED LINES
ALL BRASS CONSTRUCTION

 No.	Reference No.	Description & Representative Picture
T32	ML-3	CO ₂ blow out gun for clearing clogged oil lines and instrument transmission lines. Built-in check valve allows spent cartridge to be removed without loss of pressure. 
T32-10	ML-3-150	CO ₂ blow out gun with built-in safety valve. Limits pressure at outlet of gun to 150 PSI. Since CO ₂ cartridges produce approximately 800 PSI, the additional pressure is relieved should a severely restricted line be encountered. 
T32-11	ML-3-150-UPG	150 PSI safety valve upgrade kit for blow out gun 
T32-15	ML-3-P1000	CO ₂ blow out gun with 1,000 PSI pressure gauge. Accurately monitors pressure in the line during clearing. Constant pressure indicates line is blocked; falling pressure means blockage is moving; no pressure means line is clear. Complete kit includes blow out gun with gauge, box of CO ₂ cartridges, plastic carrying case, and instructions 
T32-16	ML-3-PQ	CO ₂ blow out gun with Quick-Connect Kit for quickly connecting to different line sizes. Kit includes blow out gun with 1,000 PSI pressure gauge, quick-connect coupling, (1) ea. 3/8" & 1/2" compression connectors, (1) ea. 3/8" & 1/2" flare connectors, plastic carrying case, and instructions 
T32-20	QCK-1 Kit	Quick-Connect Fittings Kit (blow out gun not included). Contains quick-connect coupling, (1) ea. 3/8" & 1/2" compression connectors, (1) ea. 3/8" & 1/2" flare connectors 
T32-25	"O" rings	Replacement "O" ring for blow out gun, package of 6

CO₂ CARTRIDGES & FLAME MIRRORS



Westwood

CO₂ CARTRIDGES

 No.	Reference No.	Description
T32-30	CO ₂ Cartridges	CO ₂ cartridges, 8 gram, 800 PSI, Box of 10*

* 40 boxes of 10 cartridges per case

Westwood

FLAME MIRRORS & PILOT LIGHTERS

Telescoping Handle

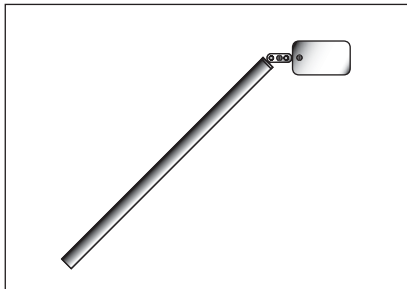

 No. T34-10

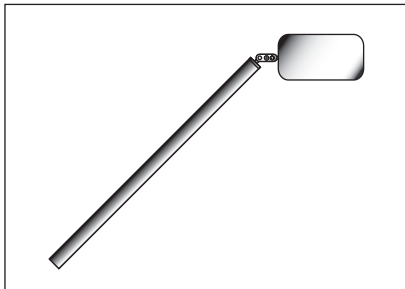

 No. T34-15

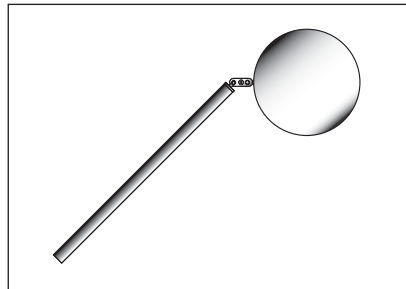

 No. T34-25

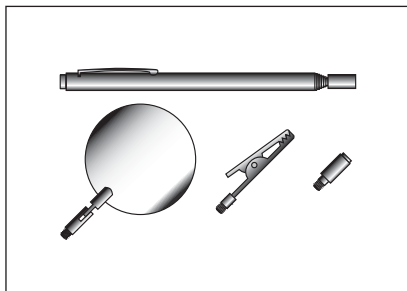



 No. T34-30



 No. T34-35



 No. T34-40

 No.	Reference No.	Description
T34-10	MR-1X2	1-1/4" x 2-1/8" telescoping rectangular flame mirror
T34-15	MR-2X3	2" x 3-3/4" telescoping rectangular flame mirror
T34-25	MR-4	4-1/4" diameter telescoping round flame mirror
T34-30	MK-3 Kit	26" telescoping tool with clip, magnet, and 2" mirror
T34-35	ML-26	26" telescoping pilot lighter
T34-40	12" Lighter	12" pilot lighter, plated handle, non-telescoping

COMBUSTION TEST EQUIPMENT

Westwood is proud to introduce the **BRIGON** line of quality combustion test equipment. One of the world's oldest and most respected manufacturers of test equipment for the heating industry, **BRIGON** offers advanced European technology at an affordable price. And while the **BRIGON** name may be unfamiliar in North America, the products will be immediately recognized as interchangeable with test equipment widely used here today.

Westwood
**OIL BURNER
 COMBUSTION TEST KIT**
BRIGON

T35 TEST KIT CONTAINS:

- CO₂ Indicator
- CO₂ Indicator sampling assembly
- Stack thermometer - 900° F
- Draft gauge & sampling hose assembly
- Smoke tester with smoke test paper and smoke scale
- Efficiency calculating slide rule
- Steel carrying case



 No. T35

Westwood
**OIL BURNER
 CO₂ INDICATOR KIT**
BRIGON

T36 TEST KIT CONTAINS:

- CO₂ Indicator
- CO₂ Indicator sampling assembly
- Efficiency calculating slide rule
- Carrying case



 No. T36

 No.	Description	Replaces Bacharach
T35	BRIGON Oil burner combustion test kit with carrying case	10-5022
T35-1	T35 kit with smoke tester & stack thermometer manufactured by Westwood	10-5022
T36	BRIGON CO ₂ indicator kit with carrying case	10-5000
T36-10	Replacement sampling assembly for BRIGON and Bacharach CO ₂ indicator	11-7029
T36-12	Replacement bulb only for BRIGON and Bacharach sampling assembly	11-0120
T36-14	Replacement red (in) check valve for BRIGON and Bacharach sampling assembly	11-0138
T36-15	Replacement green (out) check valve for BRIGON and Bacharach sampling assembly	11-0127
T36-16	Replacement rubber hose for BRIGON and Bacharach sampling assembly	11-0119
T36-18	Replacement filter tube w/yarn for BRIGON and Bacharach sampling assembly	11-0130
T36-20	BRIGON Efficiency calculating charts	-

Please order by  No.

COMBUSTION TEST EQUIPMENT

Westwood

SMOKE TESTER - POLYCARBONATE BARREL

- ▶ Virtually unbreakable Polycarbonate barrel
- ▶ Hardware all Brass and Stainless Steel
- ▶ Sampling tube hooks into smokepipe
- ▶ Fits into **BRIGON** and Bacharach cases
- ▶ Lifetime silicone lubrication

POLYCARBONATE
no dents, no corrosion!

 No. T40

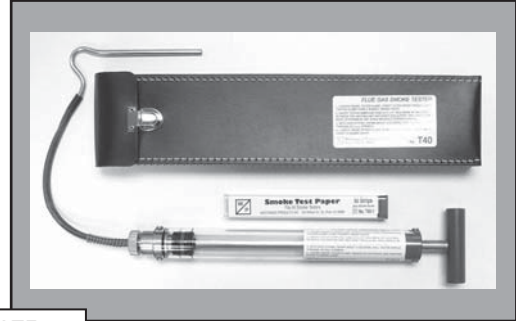

Reliable and durable instrument for measuring the smoke number of a flue gas sample. Flue gas is taken from an opening in the flue pipe and drawn through the smoke test paper mounted in the tester. Comparison of the test paper with the smoke scale determines the smoke scale number.

INCLUDES : SMOKE TESTER, SMOKE TEST PAPER, SMOKE SCALE, CARRYING CASE

Westwood

UNIVERSAL SMOKE TEST PAPER

- ▶ Precut strips for use in all smoke testers
- ▶ Includes smoke scale
- ▶ Sturdy dust & dirt proof plastic package

 No. T40-1

Pkg. of 50 strips

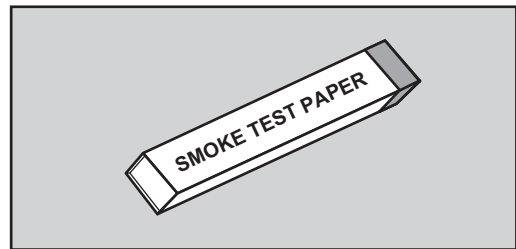

BRIGON SMOKE TESTER

- ▶ Corrosion proof construction
- ▶ Fits into **BRIGON** and Bacharach cases

 No. T41

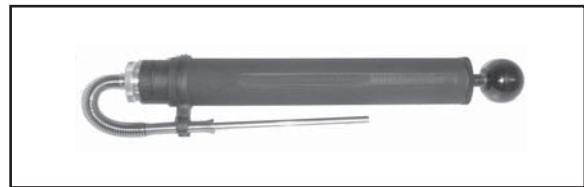

 No.	Description	Replaces Bacharach
T40	Westwood polycarbonate barrel smoke tester kit with carrying case	21-7006
T40-1	Westwood Universal precut smoke test paper and smoke scale, Pkg. of 50 strips	21-0019
T41	BRIGON smoke tester	21-7006
T41-1	BRIGON smoke test paper, Pkg. of 40 papers	21-0019
T41-2	BRIGON smoke scale	21-0018
T41-5	BRIGON smoke tester lubricant	-

COMBUSTION TEST EQUIPMENT

Westwood
STAINLESS STACK THERMOMETER

- Stainless steel construction
- 3" Face - 6" Insertion Probe
- Includes stack mounting clip
- Fits BRIGON and Bacharach cases
- Range: 200° - 1000° F



No. T42

BRIGON STACK THERMOMETER

- Stainless steel construction
- Fits BRIGON and Bacharach cases
- Range: 0° - 900° F



No. T43

BRIGON DRAFT GAUGE

- ▶ Precision instrument for accurate readings
- ▶ Tough, lightweight construction
- ▶ High visibility scale, -.25" to +.05" WC
- ▶ Requires no leveling for accurate readings
- ▶ 9' flexible hose with 5" draft probe

This precision instrument measures draft with accuracy not attainable with pocket draft or styrofoam ball and tube type gauges. Its high strength case stands up to daily use and will not damage the way Bakelite cases do.



No. T45

Westwood
CO₂ INDICATOR SERVICE PARTS & FLUID

FOR
BACHARACH & BRIGON
TESTERS



No. T50-2, -5



No. T50-3

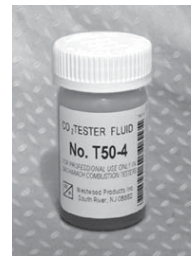

No. T50-4

No.	Description	Replaces Bacharach
T42	Westwood stainless steel stack thermometer	12-7014
T43	BRIGON stack thermometer	12-7014
T45	BRIGON precision draft gauge	13-7019
T45-1	Replacement hose & probe for BRIGON draft gauge	13-0047
T50-2	Westwood CO ₂ Indicator Repair Kit, (1) Bottle CO ₂ Fluid, Valve Plunger Seal, Top Gasket, Diaphragm, Screws, Filtering Material, Nitrile Gloves, for Bacharach	11-7052
T50-3	Westwood CO ₂ Indicator Recharging Kit, (2) Bottles CO ₂ Fluid, Top Gasket, Screws, Filtering Material, Nitrile Gloves, for Bacharach	11-7047
T50-4	Westwood CO ₂ Indicator Fluid, (1) Bottle, for Bacharach and BRIGON	-
T50-5	Westwood Repair Kit for BRIGON CO ₂ Indicator, (1) Bottle CO ₂ Fluid, Valve Plunger Seal, Top Gasket, Diaphragm, Screws, Filtering Material, Nitrile Gloves	-

Please order by No.

TESTERS FOR BURNER SERVICE

Westwood

OIL BURNER IGNITION TRANSFORMER TESTER

- ▶ Safely tests from the transformer's primary side
- ▶ Transformer remains on the burner for testing
- ▶ Detects early stages of transformer breakdown
- ▶ Easy access built-in fuse protects meter
- ▶ Simple, easy-to-read meter
- ▶ Plugs into 120 volt outlet (ie. trouble light)
- ▶ "Service Truck Tough" with high impact case

Test standard 10,000 volt oil burner ignition transformers quickly and safely with this rugged, easy-to-use tester. All testing is done from the primary side of the transformer avoiding contact with the high voltage terminals. Tests transformer right on the burner.



 No. T60

Westwood

CAD CELL RELAY & EYE TESTER

- ▶ Tests primary control and eye right on the burner
- ▶ Simple, easy-to-read and understand ohmmeter
- ▶ Built-in flame simulators for all popular controls
- ▶ "Service Truck Tough" with high impact case

Test both cad cell primary control and flame detector eye simultaneously without removing components from the burner. Built-in flame simulators for all popular controls insure accurate diagnosis and testing.



 No. T70

Westwood

"AMP-MASTER" THERMOSTAT CIRCUIT METER

- ▶ Accurately measures thermostat control circuit draw to correctly adjust heat anticipator setting
- ▶ Meter dial matches T87F heat anticipator scale
- ▶ "Service Truck Tough" with high impact case

Precisely measures the thermostat control circuit current to allow correct setting of the heat anticipator. Avoids repeat service calls to remedy short cycling or override problems. Connects at either the thermostat or relay.



 No. T80

 No.	Description
T60	Standard 10,000 volt oil burner ignition transformer tester
T70	Cad cell primary control and flame detector eye tester
T80	"AMP-MASTER" thermostat heat anticipator meter

Westwood

"EASY ACCESS" PRESSURE TESTER

0 - 100 PSI PRESSURE GAUGE • ALL BRASS CONSTRUCTION

FOR LEAK TESTING TANKLESS COILS AND PRESSURE TESTING NEW PIPING

The ideal tester for checking tankless coils for leaks, and pressure testing new piping of all types prior to building code inspections. Easily connects to any convenient garden hose thread (ie. boiler drain valve, wash tub faucet, etc.) without disturbing any fittings in the system. Built-in Schrader valve allows system pressurization with just a simple bicycle pump. Comes in a rugged, "Service Truck Tough" high impact case.

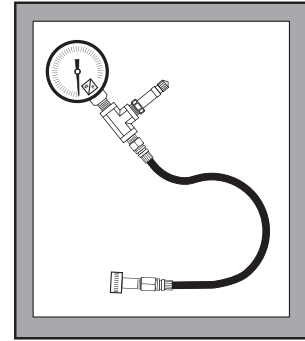
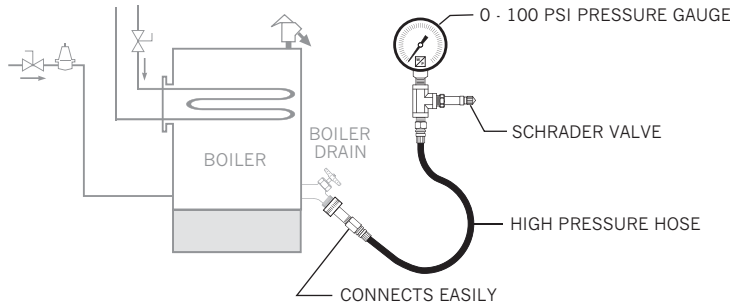

No. T90

Westwood

GAS PRESSURE TESTER

- ▶ Precision 0-15" WC "EZ Read" gauge with color coded dial for natural and L. P. gas
- ▶ 36" flexible hose with 1/8"- NPT brass adaptor
- ▶ "Service Truck Tough" with high impact case

For setting pressure of natural and L. P. gas applicances without the troublesome inconvenience and mess of water filled manometers. Gauge is precision diaphragm type with a 2-1/2" color coded "EZ Read" dial.



No. T91

Westwood

"PILOT PUFFER" LINT & DUST BLOWER

- ▶ Cleans hard-to-reach gas pilot burners and orifices
- ▶ Durable, rust proof 11" brass air tube
- ▶ Flexible, long life flexible rubber bulb

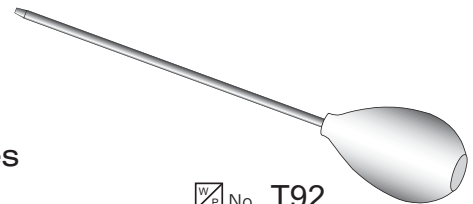

No. T92

No.	Description
T90	"EASY ACCESS" tankless coil and piping pressure tester
T91	Gas pressure tester for natural and L.P. gas
T92	"PILOT PUFFER" gas pilot and orifice lint and dust blower

Please order by No.

TEST EQUIPMENT

SMOKE PRODUCTS

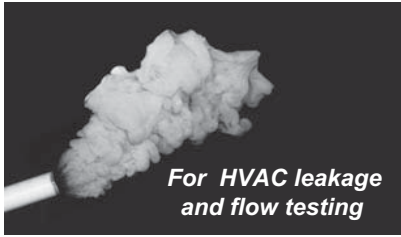

No. T95 (Series)

LOW VOLTAGE TESTER

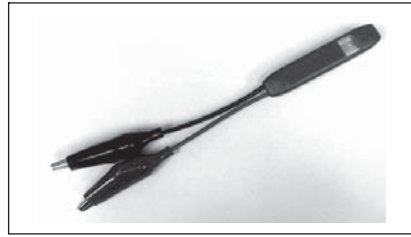

No. T100-10

LINE VOLTAGE TESTER

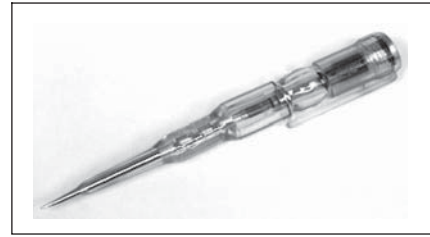

No. T100-15

CORD & CLIP SET - 8' Long

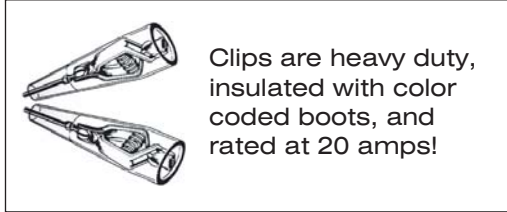

No. T100-50



JUMPERS - Insulated & non-insulated

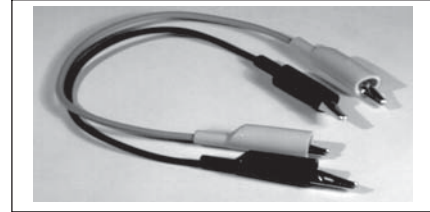

No. T100-70 through -84

POCKET DIGITAL THERMOMETER



No. T100-120

POCKET DIAL THERMOMETER

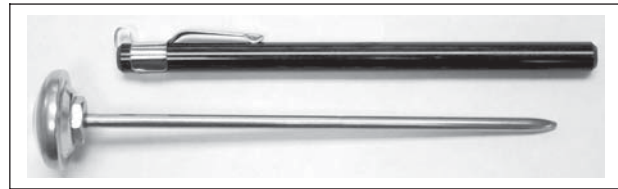

No. T100-125, -130

SMOKE, VOLTAGE TESTERS, CORD & CLIP SET, JUMPERS, POCKET THERMOMETERS

No.	Reference No.	Description
T95-20	-	Smoke emitter sticks, 20 seconds of smoke per stick, package of 20 sticks
T95-22	-	Smoke emitter pen with 6 wicks, 30 seconds of smoke per test, 60 tests per wick
T95-24	-	Smoke emitter pen refill wicks, package of 6 wicks
T95-26	-	Smoke emitter cartridges, 65 seconds of smoke, package of 10 cartridges
T95-28	-	Smoke emitter cartridges, 3 minutes of smoke, package of 5 cartridges
T100-10	LV Tester	Pocket low voltage tester, 5 - 50 VAC/VDC
T100-15	SD Tester	Pocket screwdriver line voltage tester, bright red light, 70 - 250 VAC
T100-50	7328	110 VAC/20A cord & clip set, 8' long cold weather flexible wire, w/ground wire clip
T100-70	JW-12	18 gage stranded wire jumper, non-insulated clips, 12" long
T100-72	JW-18	18 gage stranded wire jumper, non-insulated clips, 18" long
T100-74	JW-36	18 gage stranded wire jumper, non-insulated clips, 36" long
T100-80	IJW-12	18 gage stranded wire jumper, insulated clips, 12" long
T100-82	IJW-18	18 gage stranded wire jumper, insulated clips, 18" long
T100-84	IJW-36	18 gage stranded wire jumper, insulated clips, 36" long
T100-120	HDT 303K	Pocket digital thermometer, range: -40° to +300° F
T100-125	T-160	Pocket dial thermometer, range: -40° to +160° F
T100-130	T-220	Pocket dial thermometer, range: 0° to +220° F

Westwood



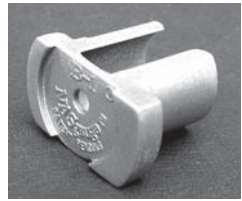



NASgauge™ NOZZLE ASSEMBLY SETTING GAUGES



NO GUESSWORK • NO BLIND ADJUSTMENTS • NO BURNER REMOVAL

Proper NOZZLE - COMBUSTION HEAD relationship without removing the burner!

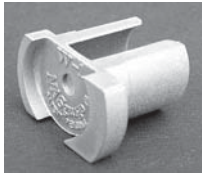
- ▶ Gauges are made of high impact polystyrene for long service life
- ▶ The B-1 & W-1 gauges are also used to set the electrode tips
- ▶ Available individually or in a complete kit containing all three gauges

 B-1 For Beckett Models AF, AFG, SR, SF with "F" heads and SF II with "FBX" head  No. T100-202	 A-1 For Aero Models HF-US, SV, SSV, F-AFC, HF-AFC  No. T100-204	 W-1 For Wayne Models EG-1, M-SR, EH-SR, EHA-SR  No. T100-206
---	--	---

EASY TO USE:

1. Slide *NASgauge™* over the nozzle.
2. Insert nozzle assembly until it touches the combustion head.
3. Mark the position of the slide plate and remove *NASgauge™*

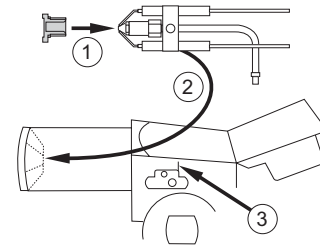

 No. **T100-200** (Kit containing all 3 gauges)

Westwood

ELECTRODE GAUGE



 No. **T100-220**

Accurately sets electrode gap and placement from the nozzle based on nozzle spray angle.

Westwood

ELECTRODE BENDERS

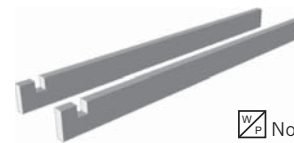

 No. **T100-230**

Pair of 5" long case hardened tools designed specifically for bending and adjusting electrode tips.

 No.	Reference No.	Description
<i>T100-200</i>	<i>NAS-ABW</i>	<i>NASgauge™ nozzle assembly setting gauge kit, (3) gauges, instructions</i>
<i>T100-202</i>	<i>NAS-B1</i>	<i>NASgauge™ nozzle assembly setting gauge for Beckett burners</i>
<i>T100-204</i>	<i>NAS-A1</i>	<i>NASgauge™ nozzle assembly setting gauge for Aero burners</i>
<i>T100-206</i>	<i>NAS-W1</i>	<i>NASgauge™ nozzle assembly setting gauge for Wayne burners</i>
<i>T100-220</i>	<i>Ignitor Gage</i>	<i>Electrode tip setting gauge</i>
<i>T100-230</i>	<i>TB-60</i>	<i>Electrode tip benders, 5" long case hardened steel, set of 2 benders</i>

Please order by  No.

COUPLER POPPER

Westwood

Coupler Popper™ with Coupler Aligner / Installer

This handy tool removes coupling ends stuck on the motor shaft from the pump side of the burner. No need to remove the motor! It also measures the proper dimension to cut a new coupling for a perfect fit, installs couplings through the pump side of the burner, and centers the pump end of the coupling for perfect alignment with the pump shaft. A real time saver that no service tech should be without.

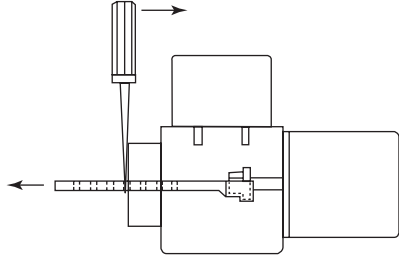

Removing stuck coupling end piece on motor shaft from pump side of burner

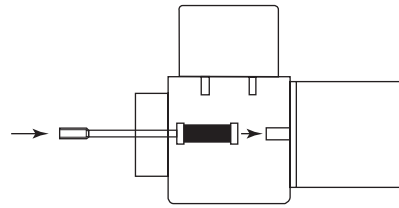

Using Aligner/Installer to install coupling on motor shaft from pump side of burner

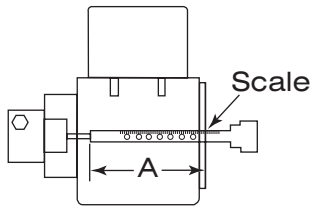

Measuring for proper coupling length (dimension "A" minus 13 marks on the Coupler Popper™ scale)

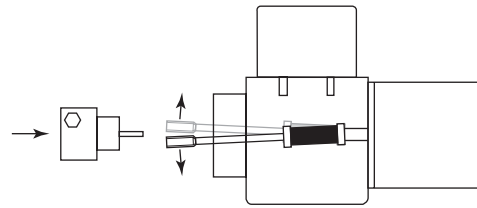

Using Aligner/Installer to center coupling end for perfect alignment with pump shaft

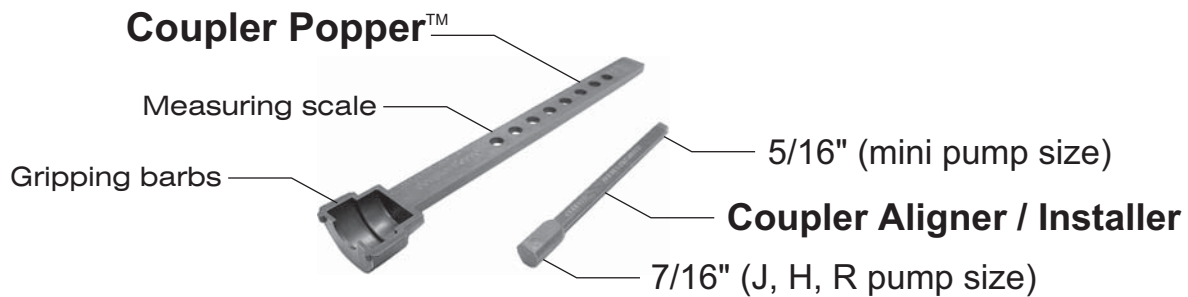

 No.	Ref. No.	Description
T100-300	CP-1	Coupler Popper™ multi purpose coupling tool with Coupler Aligner/Installer



COUPLING CUTTER on page T15

Westwood

COUPLING & GAUGE GLASS CUTTERS

Use the right tool for the job!

FIELD PROVEN • RUGGED CONSTRUCTION • QUALITY MATERIALS

COUPLING CUTTER



Cuts coupling shafts quickly and cleanly. No twisting or turning necessary. Cuts 1/8" to 1-1/4" O.D. rubber, polyethylene, neoprene, vinyl, PVC, etc. Reversible blade gives twice the blade life. Curved handles are easy on the hands.

 No. T100-310

GAUGE GLASS CUTTERS

Note: Always wear gloves and eye protection when working with glass

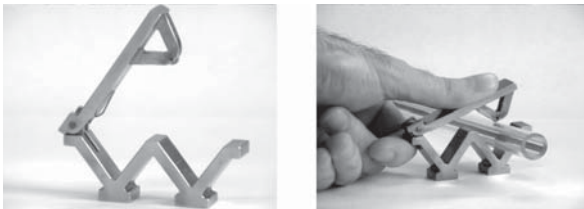

The only one recommended for cutting Red Line and High Pressure gauge glass. Cuts easily leaving a clean, straight edge. Just score and snap!

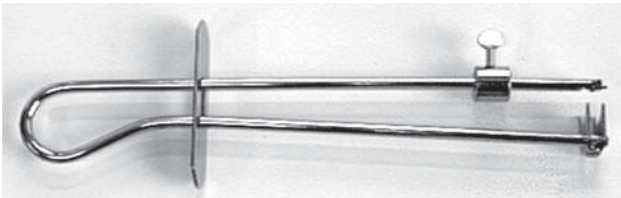
 No. T100-330

 No. T100-340

For cutting standard gauge glass. Cuts pieces as short as 1/2" or less. Set the stop to the desired length, squeeze the "trigger" and rotate the glass until it snaps cleanly in two.



 No. T100-350

For cutting standard gauge glass. Set the stop to the desired length, squeeze the handles and rotate the glass until it snaps cleanly in two.

 No.	Ref. No.	Description
T100-310	#35	Coupling cutter, heavy duty die cast metal handles, reversible blade
T100-312	#35 Blade	Replacement blade for T100-310
T100-330	WP-1	Gauge glass cutter for standard, Red Line, and High Pressure glass
T100-332	-	Replacement cutting wheel for T100-330
T100-340	#996	Gauge glass cutter with adjustable stop for standard glass
T100-342	#996-W	Replacement cutting wheel for T100-340
T100-350	RD-95	Gauge glass cutter for standard glass, adjustable stop, cast metal handles
T100-352	RD-95-W	Replacement cutting wheel for T100-350



Take a look...

Please order by  No.

T100-370 PORCELAIN CUTTER also cuts gauge glass, see page T16

rev. 5-1-04

T15

TOOLS

Westwood

PORCELAIN CUTTER

Use the right tool for the job!

FIELD PROVEN • HEAVY DUTY CONSTRUCTION • HARDENED CUTTING WHEELS

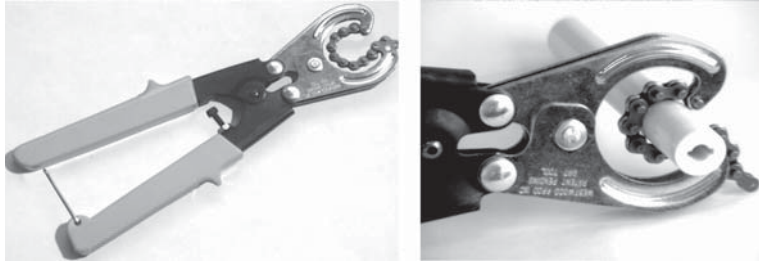

 No. T100-370

NEW DESIGN! Easier to use!

Replaces the old tool with external chain - no more wrapping the chain around! Powerful compound lever action snaps even the toughest oil burner porcelain. Hardened and tempered cutting wheels, sure-grip molded handles, hardened steel jaws, locking clasp, adjustable stop.

Also cuts standard gauge glass up to 3/4" in diameter!

Note: Do not cut Red Line or High Pressure gauge glass with this tool. The stress exerted on the glass could lower the maximum pressure rating of the glass. Use instead the T100-330 gauge glass cutter shown on page T15.

Westwood

MASTER LINEMAN'S PLIERS & CRIMPER

The Grandson of the famous Rajah™ Crimping Tool!



 No. T200-10

A service tech's dream come true! All the features of lineman's pliers, plus the ability to cut, strip, and crimp ignition cable and terminals. Hand fitted and finished to make this professional quality tool a joy to use and a pleasure to look at.

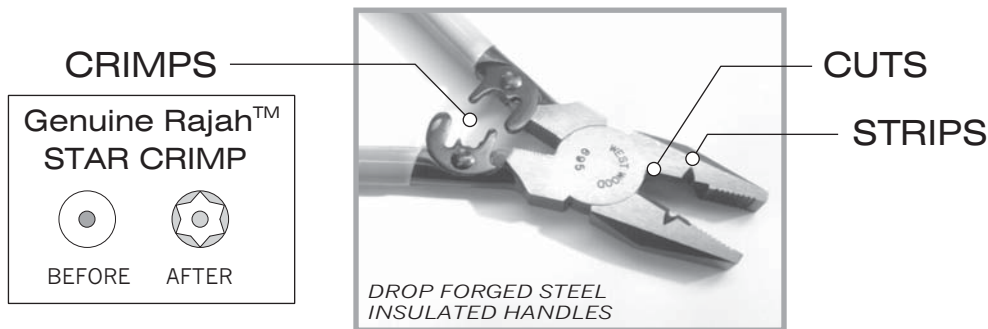

 No.	Ref. No.	Description
T100-370	#997	Porcelain & gauge glass cutter, heavy duty chain, hardened wheels & jaws
T100-372	-	Replacement cutting chain for T100-370
T200-10	#695	Master Lineman's Pliers & Terminal Crimper, drop forged steel, 8-1/2" long

Westwood
CRIMPING TOOL

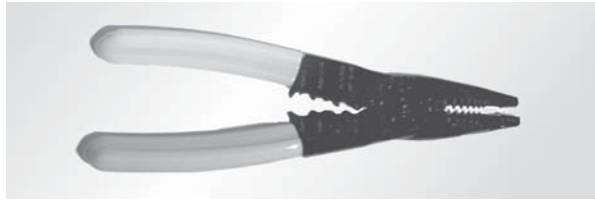

 No. T200-15

Cuts and strips #10 to #22 gage wire. Crimps standard insulated, non-insulated, and 7mm automotive type terminals. (for Rajah™ ignition terminals, see T200-10 Lineman's pliers and crimper on page T16)

Westwood
HEX KEY WRENCH SETS

HEAT TREATED!

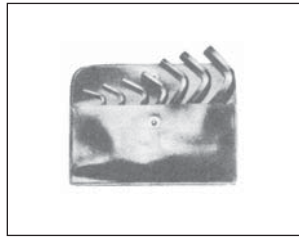

 No. T200-50

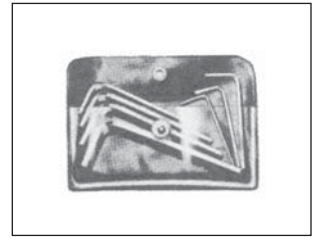

 No. T200-52

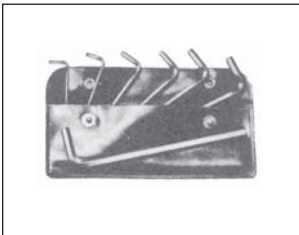

 No. T200-54

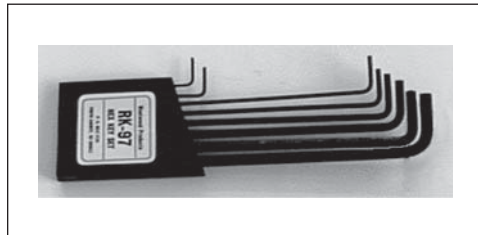

 No. T200-56



 No. T200-58

Westwood
CIRCULATOR FLANGE TOOL

For installing popular B&G and Taco circulator flanges on pipe. Use with a socket or wrench.

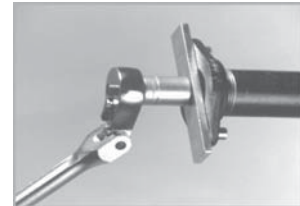

 No. T200-80

 No.	Ref. No.	Description
T200-15	#271	Cutting - Crimping - Stripping tool, for standard wire terminals
T200-50	LK-66	Long hex key set in pouch, 5/64", 3/32", 1/8", 5/32", 3/16", 7/32", 1/4"
T200-52	SK-59	Short hex key set in pouch, 5/64", 3/32", 1/8", 5/32", 3/16", 7/32", 1/4"
T200-54	XK104	6" long hex key set in pouch, 5/64", 3/32", 1/8", 5/32", 3/16", 7/32", 1/4"
T200-56	RK-97	Hex key set in case, .050, 1/16", 5/64", 3/32", 1/8", 5/32", 3/16", 7/32"
T200-58	HK-17	Folding hex key set, .050, 1/16", 5/64", 3/32", 1/8", 5/32", 3/16"
T200-80	FT-1	Circulator flange installation tool, square drive

Please order by  No.

INDEX**A**

Absorbent pads & socks, S22
 Adapter, flexible oil lines, S16
 Adapter, gauge, S11
 Additive testing, C2
 Additive, Fuel Right, C2, C3
 Additive, heating oil, C1, C3
 Alligator clip cord set, T12
 Alligator clips, E34
 Altitude gauges, H5
 Aluminum top filters, F1-F9
 Amp tester, T10
 AMP-MASTER tester, T10
 Aquastat wells, H6
 Assemblies, Auburn, E17 - E26
 Assemblies, cable, E35
 Assemblies, Champion, E28, E29
 Assemblies, filtration, F4
 Auburn products, E17 - E26

B

B&G circulator, couplings for, H4
 Bacharach, repair parts for, T9
 Bags, vacuum cleaner, S21
 Batteries, clock thermostat, E37
 Beckett nozzle line fittings, S13
 Beckett, NYLO-FLEX for, S5
 Beckett, solid state igniter, E42
 Beckett, tune-up kits for, S7
 Belts, MAX-DRIVE v-belts, S1
 Benders, electrode, T13
 BIG GUY filter elements, F6
 Black iron steam pig tails, H2
 Bleed wrench, T3
 Bleeder fitting, spin-on filter, F3
 Bleeders, radiator, H6
 Blow down kit for McD & M, H3
 Blow out gun, CO2, T5
 Blower wheels, S9
 Blue Angel tune-up kit, S8
 Boiler parts for Weil McLain, H8
 Boiler probes, Fulton boilers, H7
 Bolts, circulator flange, H3
 Boots, insulating, E34
 Brass steam pig tails, H2
 Brass, buss bars, E32
 Brazed plate heat exchangers, H9
 Brigon combustion testers, T7 - T9
 Burner end cones, S18
 Burner fans, S9
 Bushings, electrode, E32
 Buss bars, E32
 By-pass plugs, S13

C

Cable assemblies, E35

Cable, high voltage, E35
 Cable, ignition, E35
 Cable, red & white silicone, E35
 Cad cell eye, E36
 Cad cell flame detector, E36
 Cad cell tester, T10
 Can, filter upgrade kit, F9
 Canister upgrade kits, F9
 Cap, garden hose, H6
 Carlin, NYLO-FLEX for, S5
 Carlin, tune-up kits for, S8
 Cartridges, CO2, T6
 Cast iron end cones, S18
 Cast iron top filters, F2
 Cerafelt chamber liners, S2
 Ceramic boots, terminal, E34
 Ceramic spark plug boots, E34
 Chamber liners, S2
 Champion ign. assem, E28, E29
 Check valves, S17
 CHERRY BLAST odor powder, C1
 Circulator couplings, H4
 Circulator flange bolts, H3
 Circulator flange gaskets, H3
 Circulator flange tool, T17
 CLASSIC FELT filter element, F7
 CLASSIC YARN filter element, F8
 Cleanup supplies, S22
 Cleaver Brooks ring, E32
 Cleaver Brooks spring, E32
 Clips, alligator, E34
 Clips, electrical, E34
 Clips, jumper, T12
 Clock thermostat batteries, E37
 CO2 blow out gun, T5
 CO2 cartridges, T6
 CO2 indicators, T7
 CO2 tester fluid & parts, T9
 CO2 testers, T7
 COLD FLOW, fuel additive, C3
 COMBI oil de-aerator, S15
 Combination gauges, H5
 Combustion chamber liners, S2
 Combustion test equip., T7 - T9
 Commercial element, 2A-300, F7
 Commercial spin-on filters, F3
 Compound gauges, S11
 Copper gaskets, E32
 Copper oil lines, S13
 Cord & clip set, T12
 Coupler Popper tool, T14
 Coupling cutter, T15
 Coupling kits, S4, S6
 Coupling, for B&G circulators, H4
 Couplings, KUT-A-SYZ, S6

Couplings, motor, S4
 Couplings, NYLO-FLEX, S5
 Couplings, one piece, S4
 Couplings, spline, S4
 Crank arm linkage, S19
 Crimpers, terminal, T16, T17
 Cutter, coupling, T15
 Cutter, porcelain, T16
 Cutters, gauge glass, T15
 Charges, CO2, T6

D

Danfoss, strainers for, S12
 De-aerator, oil, S15
 Deodorant, C1
 Dial thermometer, H5
 Diesel additives, C3
 Digital pocket thermometer, T12
 Dirt pocket cap for McD & M, H3
 Disposal bags, S22
 Distributor nipple, E34
 Double wall heat exchgrs, H9 - H10
 Draft gauge, T9
 Draft regulator, S18
 Drop cloth, S22
 Dry comb. chamber liners, S2
 Ducane, NYLO-FLEX for, S5
 Dust masks, S22

E

EASY ACCESS tester, T11
 EASY ANGLE hand pump, T4
 Electrical clips, E34
 Electrode benders, T13
 Electrode kits, E15, E16, S7, S8
 Electrode setting gage, T13
 Electrodes, Auburn, E17 - E26
 Electrodes, Champion, E28, E29
 Electrodes, E1 - E29
 Electronic igniter, Beckett, E42
 Electronic igniter, E42
 Electronic Igniter, for Aero, E42
 Electronic Igniter, for Carlin, E42
 Electronic Igniter, for Wayne, E42
 Electronic tubes, E37
 Elements, BIG GUY, F6
 Elements, filter, 10 micron, F3, F7
 Elements, filter, felt, F7
 Elements, filter, Pure-Oil, F6
 Elements, filter, yarn, F8
 End cones, S18
 Epoxy coated canisters, F1 - F9
 Evaluating fuel oil additives, C2
 Eye, cad cell, E36
 E-Z CONNECT, S17

F

Fans, S9
 FB10, element for, F6, F8
 FB4, element for, F6, F8
 FB6, element for, F6, F8
 FB8, element for, F6, F8
 Feeder, McD & M, parts for, H3
 Felt filter elements, F7
 Fiberglass braid, E35
 Fiberglass rope, S3
 Filter canister upgrade kit, F9
 Filter elements, 10 micron, F3, F7
 Filter elements, BIG GUY, F6
 Filter elements, felt, F7
 Filter elements, Pure-Oil, F6
 Filter elements, ULTRA-10, F7
 Filter elements, yarn, F8
 Filter, canister type, F1, F2
 Filter, canister upgrade kit, F9
 Filters, commercial spin-on, F3
 Filters, dual, F4
 Filters, F1 - F9
 Filters, gaskets for, F8
 Filters, secondary filtration, F4
 Filters, spin-on, F3
 Filters, with BIG GUY element, F2
 Firomatic valve, S15
 Firomatic, elements for, F6
 Fitting, garden hose, H6
 Flame detector, cad cell, E36
 Flame mirrors, T6
 Flame rods, Auburn, E24
 Flange bolts, circulator, H3
 Flange gasket material, H3
 Flange tool, T17
 Flange, pump, S13
 Flexible oil lines, S16
 FLEXI-LINK circulator coupling, H4
 FLO-THRU pump bleed wrench, T3
 Fram, elements for, F6
 Friction washers, gauge glass, H2
 Fuel filter gaskets, F8
 Fuel oil additives, C1, C3
 Fuel oil treatment, C1, C3
 Fuel oil, filters, F1 - F9
 Fuel Right 6000, C3
 Fuel Right 7500, C3
 Fuel Right, C2, C3
 Fuel Right, fuel additive, C2, C3
 Fuel stabilizer, C1, C3
 Fuel stabilizer, Fuel Right, C2, C3
 Fuel treatment, C1, C3
 Fulflo FB10, element for, F6, F8
 Fulflo FB4, element for, F6, F8
 Fulflo FB6, element for, F6, F8
 Fulflo FB8, element for, F6, F8

Fulton boilers, level probes for, H7
 Furnace oil line kit for Miller, S13

G

Garden hose cap & fitting, H6
 Gas pressure tester, T11
 Gasket material, red rubber, H3
 Gaskets, circulator flange, H3
 Gaskets, fuel filters, F8
 Gaskets, pump strainer, S12
 Gauge adapter, S11
 Gauge glass cutters, T15
 Gauge glass friction washers, H2
 Gauge glass nuts, H2
 Gauge glass repair kit, H2
 Gauge glass sets, H2
 Gauge glass washers, H1
 Gauge glass, H1
 Gauge glass, high pressure, H1
 Gauge glass, red line, H1
 Gauge glass, standard, H1
 Gauge, draft, T9
 Gauges, altitude, H5
 Gauges, combination, H5
 Gauges, compound, S11
 Gauges, diaphragm, S11
 Gauges, hydronic, H5
 Gauges, liquid filled, S10
 Gauges, pressure, S10
 Gauges, refrigeration test, S11
 Gauges, spin-on filter, F3
 Gauges, steam, H5
 Gauges, temperature, H5
 Gauges, tester, S11
 Gauges, tridicator, H5
 Gauges, vacuum, S11
 Gauges, water level, H5
 General Filters, element for, F6, F7
 Gloves, brown jersey, S22
 Gloves, nitrile, S22
 Gloves, white canvas, S22
 Goggles, splash, S22
 GTO-15 Cable, E35
 Guards, thermostat, E38 - E40

H

Hand pump, T4
 Harvey, elements for, F3, F6, F7
 Heat exchangers, brazed, H9 - H10
 Heating oil additives, C1, C3
 Heating oil filters, F1 - F9
 Hex key wrenches, T17
 High pressure gauge glass, H1
 High temperature cable, E35
 High temperature boots, E34
 High temperature rope, S3

High voltage cable, E35
 High voltage terminals, E30 - E33
 Honeywell, immersion wells for, H6
 Hose fitting, H6
 Hot fuel oil additive test, C2
 Hot water thermometer, H5
 HV-15 Cable, E35
 Hydronic gauges, H5

I

Igniter, solid state electronic, E42
 Ignition cable, E35
 Ignition terminals & kits, E30 - E33
 Ignition transformer tester, T10
 Ignition wire, E35
 Ignition, Auburn, E17 - E26
 Ignition, Champion, E28, E29
 Ignitor (electrode) kits, E15, E16
 Ignitors (electrodes), E1 - E29
 Immersion wells, H6
 Insulation kits, heat exchgrs, H10
 Insulators, E1

J

Jar Test, C2
 Jumpers, T12

K

Key, radiator bleeder (vent), H6
 Keys, hex, T17
 Kit, blow down for McD & M, H3
 Kit, dirt pocket cap, McD & M, H3
 Kit, gauge glass repair, H2
 Kit, Miller furnace oil line, S13
 Kit, spill, S22
 Kits, burner tune-up, S7, S8
 Kits, cad cell flame detector, E36
 Kits, circulator flange bolt, H3
 Kits, circulator flange gasket, H3
 Kits, CO2 blow out gun, T5
 Kits, combustion testing, T7
 Kits, couplings, S4, S6
 Kits, electrode, E15, E16, S7, S8
 Kits, filter canister upgrade, F9
 Kits, heat exchanger insul., H10
 Kits, NYLO-FLEX couplings, S6
 Kits, Rajah terminals, E33
 KUT-A-SYZ couplings & kits, S6

L

Leak tester, T11
 Lennox, NYLO-FLEX for, S5
 Light, thermostat, E41
 Line voltage tester, T12
 Lineman's pliers, T16
 Liners, combustion chamber, S2

INDEX**L** (continued)

Lines, oil (nozzle), S13
 Linkage, crank arm, S19
 Lint and dust blower, T11
 Liq. level probes, stainless, E27
 Liq. level probe, Auburn, E25 - E26
 Liq. level probe, Fulton boilers, H7
 Liquid filled pressure gauges, S10
 Low pres. diaphragm gauges, S11
 Low voltage tester, T12
 Low water cut off, parts for, H3

M

MAGIC-PATCH oil tank patch, S13
 Magnetic oil tank patch, S13
 MAX-DRIVE v-belts, S1
 McDonnell & Miller, parts for, H3
 Miller furnace oil line kit, S13
 Mirrors, flame, T6
 Mitco, elements for, F3, F6, F7
 Motor couplings, S4
 Motor, zone valve, E41
 Mounting bracket, spin-on filter, F3

N

NASgauge nozzle tool, T13
 Nitrile gloves, S22
 Nozzle line fitting for Beckett, S13
 Nozzle lines, S13
 Nuts, gauge glass, H2
 NYLO-FLEX couplings, S5

O

Observation ports, S20
 Odor neutralizer, C1
 Oil burner blower wheels (fans), S9
 Oil de-aerator, S15
 Oil line access port, T3
 Oil line kit for Miller furnace, S13
 Oil line safety valve, S17
 Oil lines, copper, S13
 Oil lines, flexible, S16
 Oil tank patch, S13
 OSV valve, S17

P

Pads, absorbent, S22
 Paper wipes, S22
 Paper, smoke test, T8
 Petro ignition assembly, E28
 Pig tails, steam, H2
 Pilot cleaner, T11
 Pilot lighters, T6
 PILOT PUFFER lint blower, T11
 Plastic bags, S22
 Plate heat exchangers, H9 - H10

Pleated paper elements, F7
 Pliers, lineman's, T16
 Plugs, by-pass, S13
 Pocket thermometers, T12
 Porcelain cutter, T16
 Porcelains, E1
 Ports, observation, S20
 Pour point reducer, C1, C3
 Pres. tester, EASY ACCESS, T11
 Pressure gauges, S10
 Pressure-Vacuum hand pump, T4
 PRESSURE-VIEW pump tester, T1
 Probes, stainless steel, E27
 Pump bleed wrench, T3
 Pump cover gaskets, S12
 Pump flange, S13
 Pump strainers, S12
 Pump test, Suntec & Webster, T1
 Pump tester, Riello, T2
 Pump testers, T1, T2
 Pump, hand pressure-vacuum, T4
 Pure-Oil filter elements, F6
 Purolator, elements for, F6
 Push rods, linkage, S19
 PV pump, T4

R

Radiator bleeder (vent) key, H6
 Radiator bleeders (vent), H6
 Rags, polo, S22
 Rajah terminal kits, E33
 Rajah terminals, E30 - E33
 Ray burner bakelite shield, E32
 Rechargeable batteries, E37
 Red Line gauge glass, H1
 Red rubber gasket material, H3
 Reducer bushing, S4
 Refractory chamber liners, S2
 Refrigeration test gauges, S11
 Riello by-pass plug, S13
 Riello pump tester, T2
 Riello, strainer for, S12
 Rope, high temperature, S3
 Rubber couplings, S4
 Rubber gasket material, red, H3

S

Safety and spill supplies, S22
 Safety glasses, S22
 Sampling assem, CO2 testers, T7
 Saws, soot, S21
 Screwdriver line voltage tester, T12
 Secondary filtration assemblies, F4
 SERVICE-SAW cleaning tool, S21
 Set, hex key wrenches, T17

Sets, gauge glass, H2
 Shoe covers, S22
 Shovel, soot, S21
 Sid Harvey, elements for, F3 - F7
 Sight glasses, S20
 Silicone rubber boots, E34
 Sliding handle bleed wrench, T3
 Sludge Solve fuel additive test, C2
 Sludge solvent, C1, C3
 Smoke cartridges (candles), T12
 Smoke sticks, T12
 Smoke pen, T12
 Smoke test paper, T8
 Smoke testers, T8
 Socks, absorbent, S22
 Solid state igniter, Beckett, E42
 Solid state igniters, E42
 SOOT SABER cleaning tools, S21
 Soot saws, S21
 Soot shovel, S21
 SOOT SNAKE vacuum hose, S21
 Spark plugs, Champion, E29
 Spill cleanup supplies, S22
 Spill kit, S22
 Spin-on filter bleeder fitting, F3
 Spin-on filter gauges, F3
 Spin-on filter mounting bracket, F3
 Spin-on filter wrench, F3
 Spin-on filters, F3
 Splash goggles, S22
 Spring terminals, E32
 Stack thermometers, T9
 Stainless heat exchangers, H9
 Stainless steel probes, E27
 Standard electrodes, E1
 Steam boiler parts, H2 - H3
 Steam gauges, H5
 Steam pig tails, H2
 STR-2 fuel oil additive test, C2
 Strainers, pump, S12
 Strippers, wire, T16, T17
 SUMMER DIESEL, fuel additive, C3
 Suntec by-pass plugs, S13
 Suntec, strainers for, S12
 Swivels, linkage, S19
 System pressure tester, T11

T

Tank patch, S13
 Tankless coil gasket material, H3
 Tankless coil tester, T11
 Telescoping flame mirrors, T6
 Telescoping pilot lighters, T6
 Temperature gauges, H5
 Terminal crimpers, T16, T17

T (continued)

Terminal, ceramic boots, E34
 Terminals, high voltage, E30 - E33
 Terminals, ignition, E30 - E33
 Terminals, Rajah, E30 - E33
 Terminals, spring, E32
 Test equip, combustion, T7 - T9
 Test gauges, refrigeration, S11
 Tester gauges, S11
 Tester, AMP-MASTER tester, T10
 Tester, cad cell, T10
 Tester, draft, T9
 Tester, gas pressure, T11
 Tester, ignition transformer, T10
 Tester, line voltage, T12
 Tester, low voltage, T12
 Testers, CO₂, T7
 Testers, pump, T1, T2
 Testers, smoke, T8
 Thermometer, dial, H5
 Thermometer, digital pocket, T12
 Thermometer, pocket, T12
 Thermometers, stack, T9
 Thermostat batteries, E37
 Thermostat circuit tester, T10
 Thermostat guards, E38 - E40
 Thermostat light, E41
 TIGERLOOP oil de-aerator, S15
 Tool, circulator flange, T17
 Tool, Coupler Popper, T14
 Tool, crimping, T16, T17
 Tool, gauge glass cutting, T15

Tool, nozzle assembly, T13
 Tool, porcelain cutting, T16
 Torrington NYLO-FLEX adapter, S5
 Transformer tester, T10
 TRANS-TEMP heat exchangers, H9
 Treatment testing, C2
 Treatment, diesel fuel, C3
 Treatment, heating oil, C1, C3
 Tridicator gauges, H5
 Tubes, electronic (vacuum), E37
 Tubing, copper oil lines, S13
 Tune-Up kits, S7, S8

U

UL approved filter canisters, F9
 UL approved filter elements, F5 - F8
 UL approved filters, F1 - F9
 ULTRA-10 filter elements, F7
 ULTRAGLO thermostat light, E41
 Unifilter 77, elements for, F6, F7
 Unifilter 99, elements for, F6, F7
 Upgrade kits, filter canister, F9

V

VAC-PROBE oil line fitting, T3
 Vacuum cleaner bags, S21
 Vacuum cleaner hose, S21
 Vacuum gauges, S11
 Vacuum tubes, E37
 VACUUM-VIEW pump tester, T1
 Valves, check, S17

V-Belts, S1

W

Washers, gauge glass friction, H2
 Washers, gauge glass, H1
 Water dispersant, C1, C3
 Water level gauges, H5
 Water temperature gauges, H5
 Wayne, NYLO-FLEX for, S5
 Wayne, tune-up kits for, S8
 Webster by-pass plugs, S13
 Weil McLain boiler parts, H8
 Weil McLain burner electrode, E14
 Wells, aquastat, H6
 Wells, immersion, H6
 Wet combustion chambers, S2
 White filter elements, F6
 WINTER DIESEL, fuel additive, C3
 Wipes, paper, S22
 Wire strippers, T16, T17
 Wire, ignition, E35
 WP-3 fuel oil additive, C1
 Wrench, hex key, T17
 Wrench, pump bleeder, T3
 Wrench, spin-on filter, F3

Y

Yarn filter elements, F8
 Yarn filters, F2, F8

Z

Zone valve motor, E41



Take a look ...

ELECTRODE KITS and BURNER TUNE-UP KITS in Service Supplies Section pages S7 - S8

New "Kit" on the block...



Westwood is proud to introduce the **BRIGON** line of quality combustion test equipment. One of the world's oldest and most respected manufacturers of test equipment for the heating industry, **BRIGON** offers advanced European technology at an affordable price. So, while the **BRIGON** name may be new to North America, the testers look and perform like those you're using now.

Call 1-800-442-1630 for information

Westwood
Westwood Products Inc., South River, NJ 08882

Keep up to date...

EPOXY COATED
inside!

More is Better...

Westwood Spin-Ons give you...

- 25% More Capacity
Highest in their Class
- The Highest UL Approved
Flow Rate in their Class
- The Highest UL Approved
Pressure Rate in their Class
- EPOXY Coated Inside
- 10 or 30 Micron Filter Media
- UL Approved US & Canada
- Seamless One Piece Canister
(Drawn Steel)
- All Filter Heads are Threaded
for Bracket Mounting



UL APPROVED

Be Safe! Always look for
the **UL Listed** Mark



For new installations...



Westwood's line of complete filters is the largest available! All have the highest UL GPH and pressure ratings in their class, and all canisters are EPOXY coated inside.

1-800-442-1630

Westwood

Westwood Products Inc. • South River • NJ • 08882

no. T20

RIELLO
Pump Tester

UL Approved
Replacement
Canisters

no. F15-5

Epoxy coated inside

no. F100

UL Approved
Spin-Ons

Tigerloop

The Only
UL Approved
Oil De-aerator

no. S220

The World's Most Popular
Oil De-aerator

no. T10

Pump Test Kit

HEATING PRODUCTS CATALOG

no. T30

Pressure & Vacuum
Hand Pump
w/gauge

New 2005 Catalog!
Ask for your copy

no. T35

OIL BURNER
COMBUSTION TEST KIT

no. F10-48

UL Approved
Replacement
Elements

no. F15-48

Westwood

Westwood Products Inc., South River, NJ 08882
www.westwoodproducts.com phone 1-800-442-1630 fax 1-888-651-7798

EPOXY COATED
inside!



THE ONLY UL APPROVED replacement canisters

Another industry first! Westwood's new UL Recognized replacement canisters are UL approved for use on:

- General 1A-25A, 2A-700A
- Unifilter 77, Unifilter 99
- Sid Harvey (Mitoo) 264, 264F, 265, 265F
- Fulflo FB4

Be Safe! Always look for the UL
Recognized Component symbol



For new installations...



Westwood's line of complete filters is the largest available! All have the highest UL GPH and pressure ratings in their class, and all canisters are EPOXY coated inside.

1-800-442-1630

Westwood

Westwood Products Inc. • South River • NJ • 08882

...with Westwood's media ads!

For information on the latest products for the heating service industry look for Westwood's ads in the most popular trade publications.

The monkey bars and diving boards are gone...

...because of liability concerns over lawsuits. It's no wonder today's business decisions require careful thought and good judgement. Not only economic factors, but potential future liability issues must be considered. The choices made today must stand the test of time and not come back to haunt a company somewhere down the road.

Oil burner pumps, motors, ignition transformers and igniters, as well as controls, filters, and the oil burner itself are all UL approved. Why take a chance on using an oil de-aerator that is not UL approved?

Since 1987, Tigerloop has proudly carried the UL LISTED label. It is the ONLY UL approved oil de-aerator and the only one that has stood the test of time in millions of installations world-wide. Choosing Tigerloop today is a decision you can live with tomorrow.



BE SAFE! USE THE ONLY UL APPROVED OIL DE-AERATOR

Tigerloop
The Original Oil De-Aerator
1-800-442-1630
www.westwoodproducts.com

Available to the trade at supply/house everywhere. Westwood Products Inc., South River, NJ 08882

The Future is Here!



The **NEW** Tigerloop® - coming early 2005!

Westwood
Westwood Products Inc., South River, NJ 08882
1-800-442-1630



The New Tigerloop®

World's most advanced oil de-aerator
...and the only one that's UL approved!

After years of development, the next generation Tigerloop oil de-aerator has arrived! With over 30 years experience and more than 3.5 million Tigerloops installed worldwide, Tigerloop is uniquely qualified to take oil de-aeration to the next level. Designed to meet the ever increasing demands for environmental safety and system performance, the new Tigerloop leads the way to a new era of clean, efficient, environmentally friendly oil heating.

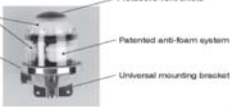

Dual chamber design for better performance and safety

33% higher de-aeration capacity

Protective vent shield
Patented anti-foam system
Universal mounting bracket

UL LISTED S220

Max. install capacity: 20 gal.	Max. install pressure into the Tigerloop: 30 psi	Max. operating temperature: 120° F (40° C)
Max. oil flow: 50 gal/h		Max. ambient temperature: 120° F (40° C)
		Max. operating pressure in feed line: 8 PSI

Connections: 1/4" NPT (female)

Westwood
Westwood Products Inc., South River, NJ 08882
1-800-442-1630

Representation WORLDWIDE...



<i>United States</i>	<i>Representative</i>	<i>Phone Number</i>	<i>FAX Number</i>
<i>NY Metro, Long Island</i>	<i>Chapman Equip., Bob Chapman</i>	<i>(516) 579-4494</i>	<i>(516) 579-0257</i>
<i>NY State, above NY Metro</i>	<i>Comfort Systems of NY, Tony Rapa</i>	<i>(315) 730-3316</i>	<i>(315) 568-9278</i>
<i>No. NJ, West/Rock Cnty NY</i>	<i>Advanced Hydronics Sales Inc., Frank Oakley</i>	<i>(201) 573-0606</i>	<i>(201) 573-0499</i>
<i>MA, CT, RI</i>	<i>Heat Tech Assoc., Tony Audia</i>	<i>(860) 482-6321</i>	<i>(860) 482-9601</i>
<i>ME, NH, VT</i>	<i>Edward B. "Spike" Lingel</i>	<i>(781) 235-8044</i>	<i>(781) 237-8999</i>
<i>East PA, So. NJ</i>	<i>N. H. Yates & Company, John Clendenning</i>	<i>(610) 495-5600</i>	<i>(610) 495-3072</i>
<i>DE, MD, VA, Wash. DC</i>	<i>N. H. Yates & Company, Jim Yates</i>	<i>(410) 667-6300</i>	<i>(410) 667-9201</i>
<i>IN, N. IL, MN, N. MI, WI</i>	<i>G. Miller Company, Gary Miller</i>	<i>(815) 964-5692</i>	<i>(815) 964-5770</i>
<i>KS, MO</i>	<i>Halfpenny Sales, Inc., Bill Halfpenny</i>	<i>(816) 776-2967</i>	<i>(816) 470-5514</i>
<i>So. MI</i>	<i>Paige & Associates, Pete Ciaramitaro</i>	<i>(248) 652-6809</i>	<i>(248) 652-3111</i>
<i>NC, SC</i>	<i>Creative Marketing Assoc., Dave Asplund</i>	<i>(803) 831-7155</i>	<i>(803) 831-7360</i>
<i>OH, KY</i>	<i>Thomas J. Finnegan Company, T. J. Finnegan</i>	<i>(937) 890-5215</i>	<i>(937) 890-6664</i>
<i>IA, NE</i>	<i>Lambert Company, Mike Lambert</i>	<i>(563) 588-2393</i>	<i>(563) 588-2452</i>

<i>Outside the US</i>	<i>Representative</i>	<i>Phone Number</i>	<i>FAX Number</i>
<i>Canada</i>	<i>E.S. Gallagher Sales Ltd., Andy Gallagher</i>	<i>(416) 789-5385</i>	<i>(416) 781-6734</i>
<i>Export Distributor</i>	<i>George Nikiforov Inc., George Nikiforov</i>	<i>(212) 473-4555</i>	<i>(212) 473-5925</i>
<i>Areas not listed</i>	<i>Westwood Products Inc.</i>	<i>(800) 442-1630</i>	<i>(888) 651-7798</i>



Westwood Products Inc.
 330 William Street, South River, NJ 08882
 Tel: (732) 651-7700 Fax: (732) 651-7798

Toll Free 1-800-442-1630
Toll Free Fax 1-888-651-7798